







EMBEDDED REMOTE GROUP ENVIRONMENT THROUGH MODIFICATION IN MACBETH – AN APPLICATION OF CONTRACTOR'S SELECTION IN CONSTRUCTION

Ali Raza KHOSO ^{1,2}, Aminah Md YUSOF ¹, Zhen-Song CHEN ^{3*},
Xian-Jia WANG ⁴, Mirosław J. SKIBNIEWSKI ^{5,6,7},
Nafees Ahmed MEMON ²

¹*Department of Structure and Materials, School of Civil Engineering, Faculty of Engineering,
Universiti Teknologi Malaysia, Johor Bahru, Malaysia*

²*Department of Civil Engineering, Mehran University of Engineering & Technology, Jamshoro, Pakistan*

³*Department of Engineering Management, School of Civil Engineering, Wuhan University, Wuhan 430072, China*

⁴*Economics and Management School, Wuhan University, Wuhan 430072, China*

⁵*Department of Civil & Environmental Engineering, University of Maryland, College Park, MD 20742-3021, USA*

⁶*Institute for Theoretical and Applied Informatics, Polish Academy of Sciences, Gliwice, Poland*

⁷*Chaoyang University of Technology, Taichung, Taiwan*

Received 28 May 2021; accepted 6 September 2021

Abstract. A group decision environment has profound roots in MACBETH (Measuring Attractiveness by a Categorical Based Evaluation Technique) analysis which indeed has plentiful advantages; however, many researchers envisage the embedded group decision system as an impediment in actual implementation. The accessibility of explicit interaction of decision makers at a single platform in the form of embedded group decision environment is a great impediment to the researchers. Accordingly, this research aims to tailor a novel alternative system of dealing with the embedded group decision under a remote group decision environment via integrating MACBETH and Exploratory Factor Analysis. The study finds that an embedded remote group decision making system could serve as an alternative system of group decision making which has plentiful perks in group decision applications. This system could help researchers to carry out research without confusing in embedded group decision environment but including all decision-makers in the model. The implication of proposed system is not only limited to MACBETH; however, due to system's versatility, a similar approach could be fruitful for other group-related environments involving collective decisions.

Keywords: MACBETH, group decisions, exploratory factor analysis, contractors, multi-criteria decisions.

Introduction

Contractors and their evaluation in a construction project persist a part of a continuous argument for the last three decades. A wrong choice of contractor leads to unsatisfactory project outcome with several challenges (Chen et al., 2021). Besides, the selection of contractor is a qualitative and a subjective approach (Russell & Skibniewski, 1990; Russell et al., 1990). The long-lasting argument of contractor selection is owing to the inherent intricacy of the topic that makes it ponderous and craves the assistance of many decision-makers (DMs) as decisions from an individual or

single DM often consider shaky and unjustified. In addition, a sound decision usually established on certain valid and scientifically proven methods and techniques such as multi-criteria decision making (MCDM). Khoso and Yusof (2020) and Khoso et al. (2021b, 2021c) believed that the case of contractor selection falls under a complex scenario of decision-making, where MCDM plays a pivotal role to resolve the confrontation of right selection. Nonetheless, the MCDM decisions are often established at the mercy of DMs. Elsayah (2016) asserted that DMs have a

This article was originally published with error. This version has been amended. Please see Corrigendum <https://doi.org/10.3846/jcem.2022.16861>

*Corresponding author. E-mail: zschen@whu.edu.cn

Copyright © 2021 The Author(s). Published by Vilnius Tech Press

This is an Open Access article distributed under the terms of the Creative Commons Attribution License (<http://creativecommons.org/licenses/by/4.0/>), which permits unrestricted use, distribution, and reproduction in any medium, provided the original author and source are credited.

prominent part in multi-characteristic assessments such as contractor selection. DMs assist in administering sophisticated challenges, primarily, when the information is fragmented (Mohemad et al., 2010; Russell & Skibniewski, 1988). Thus, DMs aid in aligning the decision process smoothly, keeping in view the nature and complexity of the problem.

The involvement of DMs' group in solving decision problems are respected and often resulted in an advantageous outcome. In contrast, a single DM entails prejudiced decisions and add mistrust in real output (Taylan et al., 2017). DMs, in the form of the group decision-making process (embedded group), is a hot topic of all the time in various decision sciences (Pang & Liang, 2012). Owing to diverse skills, experiences, knowledge, and viewpoints in distinct DMs, an embedded group could build better decision rather the individuals. Consequently, many pieces of research, such as those containing multi-criteria are centered on a group of DMs because of combined diverse judgmental skills comparing to an individual (James, 2004). Regardless of the benefits, in many cases, the accessibility of explicit interaction of DMs is not viable to some extent. In continuation of this, the true implementation of group decision-making fails, resulting in a lack of broader knowledge and a narrow problem structure and understating. This is considered as a significant challenge in adopting the perks of group decision making. Besides, the groups of DMs are not always immune to errors and free from weakness and unsound decisions (Mateus et al., 2017). In some cases, the bias results obtained from a group of DMs which considered inappropriate as highlighted in the study of Mateus et al. (2017).

Ignoring the pros and cons of group decision making, in many cases, a system of a platform, either physically or on the web is not feasible to organize. Many deadlocks confront a researcher while constructing the foundation of new research owing to the problem of the congregation, a large group at a single platform. The status quo of grouping all DMs simultaneously is subjected to a variety of factors such as time, reconciliation of all DMs for a debate with other experts, non-incentives to DMs, etc. This case is even graver in some backward and developing countries where it is almost impossible to gather all highly profiled experts from the distinct public and private organizations on a researcher's call. Moreover, this process entails a single room to spot a standard solution through several interactive and iterative methods, which is practically not possible in many circumstances, especially, in developing countries. The DMs cannot afford a single schedule, and, in many cases, they are not interested in signing up to have the debate. In addition, if ideas of a group of DMs are imbalance and not aligned, chances of disagreements may create tensions. This fear is another impediment in the way of creating an embedded group.

The embedded group decision making is a prevailing practice in MACBETH (Measuring Attractiveness by a Categorical Based Evaluation Technique). MACBETH calls a group of DMs to formulate problem structure, evaluate the case and offers their common judgements.

The entire process is highly subjected to group DMs' mercy, and a unanimous decision is established at the end. This technique has magnificently been employed in many group decision-making applications where groups of experts are invited to resolve a common problem. However, it is hard to pinpoint and acquiesce the ideas of each expert for the same issue. The status quo is even worse when the objective is very exhaustive, as in the case of a contractor's selection that entails an exceedingly more significant number of criteria and sub-criteria (attributes). The problem further sparks, while there is a more significant number of different experts with diverse backgrounds and knowledge are part of the group. This is also confirmed by Taylan et al. (2017) that hardly ever all DMs have the same philosophy while offering their inputs; furthermore, everyone views the problem contrastingly. Exploring a pool of studies, unfortunately, none of the research has focused on group DMs in MACBETH except (Mateus et al., 2017; Vieira et al., 2020). Vieira et al. (2020) proposed a web-Delphi method for group conferences, whereas, Mateus et al. (2017) proposed a method of web-MACBETH through experts' voting. The idea of web-Delphi and web conferences is profitably presented and implemented in the past, but as declared, in many cases owing to several challenges and obstacles, an individual platform is not viable to devise. The process of web-Delphi is graver as it requires sufficiently long and repetitive group meetings and discussions. The present study attempts to support the problem of embedded group decision making in classical MACBETH via an application of contractor selection. This narrative would support and encourage a facilitator (researcher) to overlay an embedded decision environment's unpaved path as the direct interaction is not required anymore. Thus, the proposed system would create further easiness in designing and developing the models and exploring the new investigations.

Another interesting point of investigation in group decisions in MACBETH analysis is the rankings of elements (such as criteria or sub-criteria). The MACBETH does not rank the elements, unlike the Analytical Hierarchy Process (AHP) or Analytical Network Process (ANP). These MCDM techniques have the advantage of computing the element weights along with the order of preferences. Nevertheless, owing to several reservations, the use of AHP or ANP is either limited or obsolete. AHP is not the best method to score more essential criteria like in contractor selection, especially, when the criteria are not independent (Semaan & Salem, 2017), and cannot maintain the interdependencies (El-Abbasy et al., 2013). In contrast, ANP is slightly stiffer and more time exhausting, limiting it from having a more extensive presence in the literature (Jato-Espino et al., 2014). Another dilemma is the consistency validation in both techniques. The weight computation process in MACBETH, on the other hand, is on the benevolence of DMs, where the element weight leans on the attribute order in the value judgment matrix. Likewise, Bana e Costa and Vansnick (1994) asserted that the ranking of attributes is conceivable with the help of DMs either in the shape of pairwise judgmental information (swing

weights) or via direct discussions with DMs. However, in earlier studies, the swing ratings of pairwise preferences and the direct rating methods had been under criticism. Researchers believe that there is no scientific support in the direct rating method. Moreover, the swing weighting method is less intuitive, more confusing, less straightforward, and challenging to work and is beyond the mental capabilities of DMs and further creates psychological clashes and hostilities among DMs (Monat, 2009).

MACBETH analysis is extensively employed in various academic research-oriented and real applications owing to its plentiful primacy. Nevertheless, the problem of embedded group decision making yet exists that is either not addressed on a larger scale or very limited to claim on ground. Despite the available alternates in the form of web-conferencing, in many cases, the feasibility of scientifically arranging such conferences is an additional challenge. Further limitations exist in its basic structure of elements' orders that have an enormous impact on the outcome (i.e. the following swing or direct weight method). Looking at this gap in the literature, there is an immense necessity of an alternate method that is not limited to the interaction of an embedded group of DMs. The present study aims to work out the possible resolutions of provoked claims with an application of contractor selection to further strengthen the study outcome. To the best of our knowledge, several attempts have made to dig out the technical hitches in MACBETH application; however, the essence of the construction contractor that is the most vibrant and intricate realm has discussed imperceptibly. This research is thus another application of MACBETH in the least investigated research realm from MACBETH's point of view.

This investigation aims to tailor a novel system of embedded remote group decision making. In past, web-conferencing methods has been successfully implemented; however, their application is an impediment to many researchers. The main contribution and knowledge gap of the study is presented below:

- i. Application of MACBETH requires a platform of group of decision-makers which is an impediment in the group decision making system. The application of the proposed system assists in overcoming the issues of embedded group decision environment.
- ii. A novel concept of embedded remote group decision making system is the major contribution of this study. This system could serve as an alternative to physical one-on-one meetups, and web-conferencing, which is an impediment to many research facilitators.
- iii. An integration of EFA in MACBETH analysis to achieve ordinal data in the form of attributes' ranking is another novel contribution, and a knowledge gap.

The rest of the paper is organized in the following sections. Section 1 highlights the research justification for this study and formulation of the problem. Section 2 contains the rationales on contractor selection, its background and development. Section 3 overviews the classical

MACBETH in detail where attribute's rating and weight-age explained exhaustively. Section 4 entails the proposed formulation process of embedded remote group decision making system with MACBETH modification. Section 5 covers the application of proposed embedded remote group decision making system in contractor selection in three distinct phases, i.e., structuring evaluation, and model improvement phase. Section 6 discusses the proposed embedded remote group decision making system, whereas, the implication and study limitation are covered in Section 7. Finally, conclusion and future directions are provided.

1. Research justification and problem formulation

The MACBETH is a powerful and glamorous tool for assessing the criteria weights. This applies a robust exchange of its scale to adjudicate the criteria input applying linear programming. Ferreira et al. (2016) claim that MACBETH is an interactive approach with underlying advantages such as simplicity and understandability, which generates a robust solution where justification and agreement are not contrary. The underlying benefits of MACBETH empower a transparent and straightforward trade-off between the criteria (Bana e Costa et al., 2005). MACBETH also improves in finding more precise results as respondents do not need to think quantitatively while comparing two criteria simultaneously. Ertay et al. (2013) asserted that the MACBETH avoids the forceful decisions from the DMs as in other numerical scale methods.

MACBETH is a systematically well-established decision-making technique with a wide range of real-world applications (Bana e Costa et al., 2008). Ferreira et al. (2012) applied this technique to assess the performance of several bank branches in Portugal. Cox et al. (2013) used MACBETH in prioritizing the diseases responsible for climate change. The application of MACBETH in bid evaluation was found in the study of Bana e Costa et al. (2002). The study established a group responsible for structuring, ranking, and evaluating the elements of the model. Besides, Joerin et al. (2010) successfully tested MACBETH on drinking water utilities, where a diverse panel of three experts involved in the formulation of models individually. However, the value-judgment in the form of semantic information of criteria carried from a single expert. Each time one expert is involved in the process depending upon the nature of the problem. Here the essence of an embedded group decision is not fully covered. Moreover, in other researches, group meetings may entail one to two days of interactions as claimed by Bana e Costa et al. (2002) in their article.

Carnero and Gómez (2016) employed MACBETH on the topic of real health care maintenance policies. A group of diverse experts formed to formulate the model structure and identify criteria, levels, and alternatives. The question of the combined value judgment matrix resolved uniquely. The response of every individual expert compiled, and later the facilitator (researcher) marked all the responses in

different ranges. Say, half experts believe that the importance of a criterion over others is on the semantic scale is “strong”, whereas, half group in favour of “very strong”, the response would be considered as “strong to very strong”. This may be feasible in instances of a small number of experts and a small number of criteria as in past work. Inversely, in the case of a larger number of experts and criteria, the embedded group decision concept is enormously challenging to apply. Moreover, the solution does not offer full-scale explanations in case of an asymmetric response from a group of experts. In contrast, a two-stage embedded group decision mechanism is proposed in the case of a real estate application by Ferreira et al. (2016). The formulation of a model comprising the identification of factors performed individually, whereas, a group workshop called containing DMs in a single room to compute a combined value judgment matrix. In addition, Mateus et al. (2017) utilized the MACBETH in sustainable redevelopment application where the web-MACBETH process devised to interact and communicate all DMs. Another application of MACBETH found in an article published by Gonçalves et al. (2019) in the field of small and medium-sized enterprises (SME). The research founded on group meetings organized at three different stages: for identifying the criteria, formulation of the overall structure, and the evaluation phase.

Owing to several associated challenges in forming embedded group decision making, a single DM is responsible for the formulation of structure, identification of attributes, and the evaluation. These applications are found in computing human performance (Gurbuz, 2010), performance analysis in project management (Marques et al., 2011), project controlling and performance (Lauras et al., 2010), supply chain management (Clivillé & Berrah, 2012), technology selection (Tosun, 2017), solid waste landfill (Demesouka et al., 2016), business location selection (Bachrane et al., 2016), auditing predictive maintenance program (Bana e Costa et al., 2012), port performance (Madeira et al., 2012), power plant (Andrade et al., 2016), portfolio management (Lourenço et al., 2012), renewable energy (Ertay et al., 2013), and steam boiler selection (Kundakci, 2019).

In the aforesaid embedded group decision making cases of MACBETH, the research incorporated either one-on-one discussion of all experts in a single room or interacted with the aid of a web-conferences. In the majority of instances, at the end of the day, all experts agree on a specific solution irrespective of interaction platform, and later the developed model is verified. In a few cases, only solo DM invited to develop the model; however, this does not genuinely reflect the concept of embedded group decision, and also deviates from the real purpose of a group discussion. In such cases the actual challenge of the grouping of all experts in a single platform is discussed very limitedly. Quite a few studies have focused on this critical issue that demands desperate attractions from researchers.

Apart from aforementioned limitations of exploring the impediments of embedded group decision making in

MACBETH, another major drawback in MACBETH is a ranking of attributes via swing or direct rating method. Direct or swing rating approach in the classical method founded upon either unrealistic preferences requires a finitely broader pairwise comparison that adds the additional complexity in holding decisions and or relatively more intricate procedure. Furthermore, this rating approach can be best adopted in the case of one-on-one interaction of a group of decision-makers, and the feasibility of the method for a remote group decision environment is questionable. The ratings of attributes in MACBETH are thus subjected to critical and complex analysis and discussions between DMs' embedded groups. Barfod and Salling (2015) and Dabrowski (2014) also claimed that the swing rating approach is one of the most intricate and problematic in its application. Edwards and Barron (1994), Keeney and Howard (1993), Winterfeldt and Edwards (1986) believed that the critical methodological issues of computing value judgment are variations of final judgments while applying the swing method. Apart from the generalization of swing method in other approaches, Danielson and Ekenberg (2019) confirmed that the concept of swing weight in MACBETH is rather exceptionally tough to attain in a group of DMs because of radical arduous nature of the approach. In contrast, Konidari and Mavrakis (2007) criticized the application of the direct rating approach in utility theory methods such as MACBETH. Either of the method (i.e., direct rating system or swings) is not excellent compared to other multi-criteria decision techniques as claimed by Bana e Costa and Chagas (2004) and Khoso et al. (2021b). Irrespective of swing or direct rating approaches, MACBETH grants the ultimate mandate to experts' panel in order to rank the elements in the course of the initial phase of group discussion (Ferreira et al., 2012; Gurbuz, 2010; Marques et al., 2011).

2. Rationales in contractor selection – background and development

Traditionally, researchers believe that the successful construction project receives the lowest bid from contractor (Topcu, 2004). Besides, new school of researchers argued with the traditional lowest price, and claimed that the method looks attractive to the client, but in the long term, it has never been a wise choice but a fundamental cause of project failure (Chen et al., 2020, 2021). In addition, Awwad and Ammoury (2019) claimed that no doubt the method is most accepted, but it does not necessarily result in the project's best performance. Persisting many loopholes in the lowest bid price contractor selection, the competent authorities brought deviation in the system by introducing multiple criteria decision systems, called multi-criteria decision support systems (MCDSM), in addition to the solo bid price.

Several studies are conducted to develop MCDSMs for contractor selection. Cheng and Li (2004) concluded that the project's performance would be highly affected when inappropriate methods are used in terms of contrac-

tor selection. Many attempts were made in the past and recently to work out a suitable mechanism in the form of a decision model to overcome this pertaining issue. A series of essential decision models based on various approaches were developed for contractor selection. The growing numbers of contractor selection models indicate there are still shortcomings that require further attention in investigating this field.

To develop a MCDSM for contractor selection, initially, it entails input in the form of decision criteria. In literature, several authors worked on selection criteria and agreed on a few criteria for contractor selection such as; experience and past performance personnel capability, financial soundness, safety, equipment capability, quality, the reputation of firm, current backlog and workload, relationships, technology, organisational structure, local geographical information, time and cost overruns in past projects, questions/answer sessions and accessibility to sub-contractors (Khosro & Yusof, 2020). However, none of the studies has gone beyond these primary criteria. Several MCDSM on contractor selection proposed based on dissimilar criteria and Multi-Criteria Decision Making (MCDM) techniques to provide the solutions for the appropriate contractor selection. Nonetheless, those models are either too complex in terms of data input, with complicated subjective, oriented on few criteria or impractical (Semaan & Salem, 2017; Xiao et al., 2020). Holt (2010) criticised the advanced model and stated that none of the models have been applied in the public sector due to recent complexity models. Several studies have developed decision making models and systems to overcome the problem of capable contractor selection by considering the technical and financial bids. For instance, a model developed by Zhao et al. (2020), but regrettably, the study deliberated quite a few model criteria for the system on which the selection is somewhat questionable. Several similar cases were found where studies have focused quite a few model criteria (Birjandi et al., 2019; Cheng & Li, 2004; Darvish et al., 2009; El-Abbasy et al., 2013; Minchin Jr. & Smith, 2005; Lam & Yu, 2011; Liu et al., 2015; Marcarelli & Nappi, 2019; Watt et al., 2010). A few other single-stage models were proposed by Anagnostopoulos and Vavatsikos (2006), Semaan and Salem (2017), Vahdani et al. (2013), Wang et al. (2013) and Yang et al. (2016), where the technical evaluation is diluted and ignored the primary consideration of evaluation criteria.

In addition to the above discussed systems and models, various other attempts have been made to devise MCDSM. However, the models are subjected to dissimilar concepts, and researchers are not agreed on a single suitable solution. For instance, a two-stage model by San Cristóbal (2012) which involved a process of final selection based on project completion time and bid price. Likewise, Liu et al. (2017) designed a two-stage system where the final award was based on health, safety, environment (HSE), technology, and bid price basis. Marcarelli and Nappi (2019) developed another two-stage model constructed on Analytical Hierarchy Process (AHP), wherein

after the technical qualification assessment, the final award subjects to the least completion time and the lowest bid. Similarly, Zhao et al. (2020) applied efficiency method to initially prequalify the contractors, and later those contractors were allowed to offer any financial bid, and the final award is subject to the consent of decision makers (DMs) centred on the solo bid price. Marović et al. (2021) developed a model but inappropriate quality criteria were considered for the model.

The method used in selecting the contractor must be transparent and straightforward so that it becomes easier to explain why a particular contractor was unsuccessful. In contrast to this, it was found that most of the models are extremely complex and bias. Many of the models are based on the choice of a few DMs such bias decisions are not compatible with the contractor's choice. Additionally, most models have a weakness in identifying the relative weights of the decision criteria such as Partial Least Square (PLS) based models, which require a supplementary technique to decide criteria weight at an earlier stage. Moreover, some models are complex and require an amount of historical data, such as ANN-based models, whereby in those models the user acquires extensive mathematical background and requires big data to collect; furthermore, understanding and running the analysis is another challenge.

To overcome simple models' shortcomings, the researchers developed even more complex and hybrid models, such as combining two or more different MCDM or based on human intelligence such as big data and fuzzy models. Apart from their robust nature, the models are based on more complex mathematical formulations, and less user-friendly. Holt (2010) reviewed several contractor selection models and criticised that the latest developed model is too complicated, which is why none of the models has been applied in the public sector. Apart from this, most past models are subjective, general, and specifically suitable for a particular environment.

3. Classical MACBETH

MACBETH is a multi-criteria decision-making technique classically based on linear programs where elements are assigned absolute numbers to the set say A (Bana e Costa & Vansnick, 1994). It was developed in 1994 by C. A. Bana e Costa and J.-C. Vansnick and later restructured in 2004. MACBETH is a method that can competently resolve complex strategic problems involved in decision-making problems, predominantly those involving quantitative and qualitative data. This operates on the additive value model, aiming to prioritize the options and weights the criteria. Its decision is humanistic, constructive, and interactive that develops a value-based model on qualitative judgment differences and supports the path from ordinal to cardinal preferences.

MACBETH implies a pairwise semantic scale, which is also a common feature of AHP also. However, there is a fundamental divergence in Saaty's scale and MAC-

BETH semantic scale, the prior works on ratios; however, the later based on differences. There exists a more technical difference in Saaty and MACBETH scales. The Saaty’s pairwise scale represents exact values, i.e., one real number to each quantitative representation of importance level at two sides, whereas, in the case of MACBETH, it is unique and does not lay on any side. The semantic scale was first developed by Charles Osgood and his team in the 1950s (Osgood et al., 1957). Since then, a large number of researchers have exploited this scale (Bernard, 2006), because these scales are simple to construct and administer. The MACBETH semantic scale exemplifies the quantitative information as non-exact and interval based, allowing more flexibility (Bana e Costa & Vansnick, 1994).

The existence of uncertainty is a universal characteristic of decision science. The uncertainty phenomena evolve; when a group of DMs has to decide the credit and financial strength, or management capability and reputation of a contractor company using the numerical data. In such situations, the quantitative assessment tool (as in AHP and ANP) does not facilitate the DMs anymore and the qualitative tool entails further elaboration. This claim is supported by Jaskowski et al. (2010), who emphasized that this is more suitable to articulate the data based on a verbal or written descriptive scale rather than numbers. A similar scientific approach is applicable in MACBETH analysis. The illustration of the typical MACBETH process, i.e., M-MACBETH, is demonstrated in Figure 1. According to Figure 1, typically, there are three major phases involved in MACBETH process namely; structuring, evaluation, and model improvement phase. Structuring phase entails the basis of this process where DMs are involved either physical or via a web platform. Evaluation phase is responsible for value judgements from DMs and computing criteria weightage. In the end, the model is improved to attain viable outcomes.

3.1. Attributes’ rating in classical MACBETH

According to Bana e Costa et al. (2003), the attributes’ rating follows the first linear programming condition in MACBETH. This condition is the foundation of ordinal information that later transforms into cardinal information. Initially, the attributes ranked in the decreasing order as per **Condition 1** as below.

Let us assume Z be the finite element set. The case further measured in such a way that each element $m, n, o, s (\in Z)$ is associated with a number $P[\forall P \in \{1, 2, \dots, 7\}]$ that satisfies the following condition.

Condition 1:

$$\forall m, n, o, s \in Z : [m \text{ is more attractive than } n \Leftrightarrow m > n \wedge o \text{ is more attractive than } s \Leftrightarrow o > s], \tag{1}$$

where $m, n, o,$ and s represent the k^{th} criteria.

Condition 1 presumes the ratings of attributes in the decreasing order in a more precise and straightforward way.

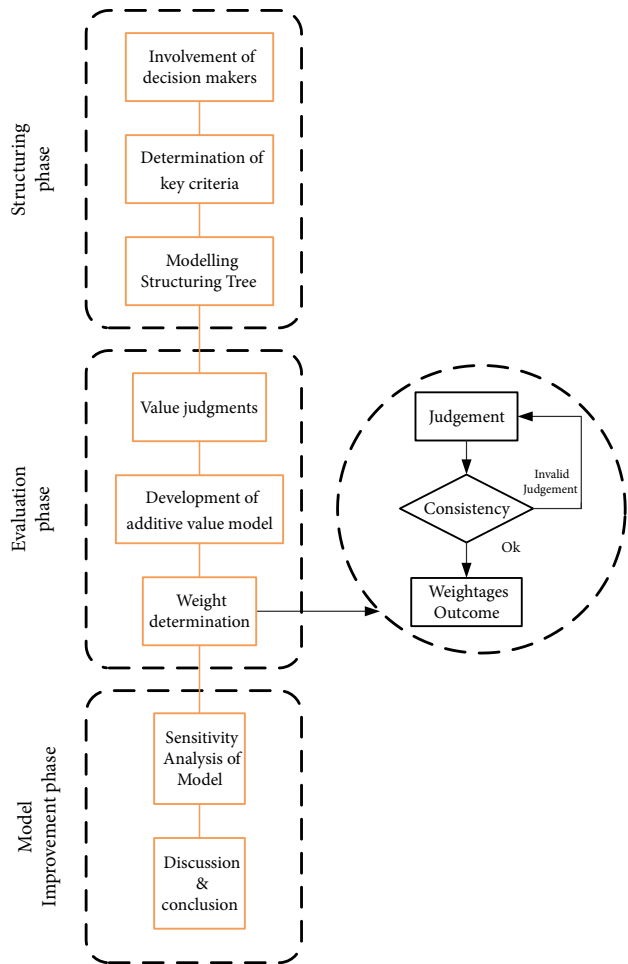

Figure 1. Typical classical MACBETH process in M-MACBETH software

Two methods are standard to satisfy Condition 1 in the MACBETH, i.e., direct (importance) rating, and the swing weight method. In the direct rating method, the DMs rank the attributes from best to worst in decreasing order of preferences. Sometimes this approach follows a relative importance method such as the best and worst assign a value of 100 and 0, respectively. All the residual attributes are assigned intermediate values and may be normalized to 1 later on. However, this method is criticized by Bana e Costa and Vansnick (1994) while presenting the MACBETH technique for the first time. It is because the pioneers of the method believe that the DMs may have a complication in adopting this method as this does not offer any technical aid to DMs. Furthermore, they suggested applying any soft method for the ranking purpose. Owing to drawbacks in the direct rating method, many researchers followed a swing weighting method in MACBETH to satisfy Condition 1. However, this never means that the direct rating method is utterly obsolete in MACBETH analysis as still, the shreds of evidence are available in the literature.

In the swing weight method of MACBETH, a panel of experts has final authority to rank the elements in the initial phase of discussion. Different approaches are pre-

Table 1. Preference matrix through swing rating method (adopted from Gonçalves et al., 2019)

	Criterion 1	Criterion 2	Criterion 3	Criterion 4	Criterion 5	Total	Rating
Criterion 1	–	1	0	0	0	1	4
Criterion 2	0	–	0	0	0	0	5
Criterion 3	1	1	–	0	0	2	3
Criterion 4	1	1	1	–	0	3	2
Criterion 5	1	1	1	1	–	4	1

ferred to explain the term “swing” weights, such as pairwise comparison of preference (see Table 1). Besides, the direct swing rating method based on DM(s) preferences is also widely applied.

Table 1 shows that the swing rating method applies to compute preferences before forming a value judgment matrix. When a panel agreed that a criterion, say criterion 1 preferred over another criterion, say criterion 2, then a value of 1 is assigned otherwise 0.

3.2. Attributes’ weightages in classical MACBETH

Attributes’ weightage is a major step in MACBETH analysis which is typically computed using a pairwise judgment of cardinal information in seven-point semantic scale (as shown in Table 2). The process of cardinal information in MACBETH follows the subsequent process using Condition 2 of MACBETH (Bana e Costa et al., 2003; Bana e Costa & Vansnick, 1994).

Let us assume we already have ordinal information from **Condition 1** and later $\forall (m, n), (o, s) \in P$, then:

Condition 2:

$$\forall m, n, o, s \in Z:$$

$$[mPn \Leftrightarrow v(m) > v(n) \wedge oPs \Leftrightarrow v(o) > v(s)], \quad (2)$$

$$\forall m, n, o, s \in Z, \forall (m, n), (o, s) \in P:$$

$$[v(m) - v(n)] / [v(o) - v(s)]. \quad (3)$$

For the cardinal information (attractiveness), a way is to place the elements of Z on a vertical scale (i.e., positioned above on the vertical scale):

$$m >^P_i n, \quad (4)$$

$$o >^P_i s. \quad (5)$$

Here, m is moderately greater than n and o is weakly greater than s , and there is k number of criteria; therefore, this is equivalent to:

$$v(m) - v(n) = 4\mu; \quad (6)$$

$$v(o) - v(s) = 3\mu, \quad (7)$$

where μ is a coefficient that necessary to meet the condition $v(m), v(n), v(o), v(s) \in [0, 100]$. The next step entails finding criteria weights by computing the final value judgment matrix and analyzing it into M-MACBETH software.

Table 2. MACBETH’s semantic scale of judgment

Semantic scale of differences	Numerical scale	Measurement
Null	1	No difference
Very weak	2	A criterion is very weakly attractive over another
Weak	3	A criterion is weakly attractive over another
Moderate	4	A criterion is moderately attractive over another
Strong	5	A criterion is strongly attractive over another
Very strong	6	A criterion is very strongly attractive over another
Extreme	7	A criterion is extremely attractive over another

These values attained through an additive value model of the following type (Eqns (8) and (9)):

$$V(Z) = \sum_{i=1}^k w_i v_i, \quad (8)$$

$$\sum_{i=1}^k w_i = 1, w_i > 0. \quad (9)$$

The aforementioned classical MACBETH process is followed in three stages: the structure formulation, evaluation, and model development phase. Each stage of classical MACBETH follows with the directions of an embedded group decision-making process. The entire flow of the process is guided by individual, or groups of DMs with M-MACBETH computer software’s aid, as demonstrated in Figure 2.

Figure 2 depicts that in classical MACBETH process of embedded group decision-making, a group of experts, i.e., DMs are engaged via a rigorous phase of discussion either individually or in the form of physical group discussions. This phase is responsible for initial investigations concerned with identification of factors and later on, deciding the finalisation of factors. In later stage of evaluation, criteria weightages are discussed and computed via a similar group decision-making process. Likewise, the final stage of model improvement involves a critical discussion of experts along with the aid of M-MACBETH software, i.e., sensitivity analysis.

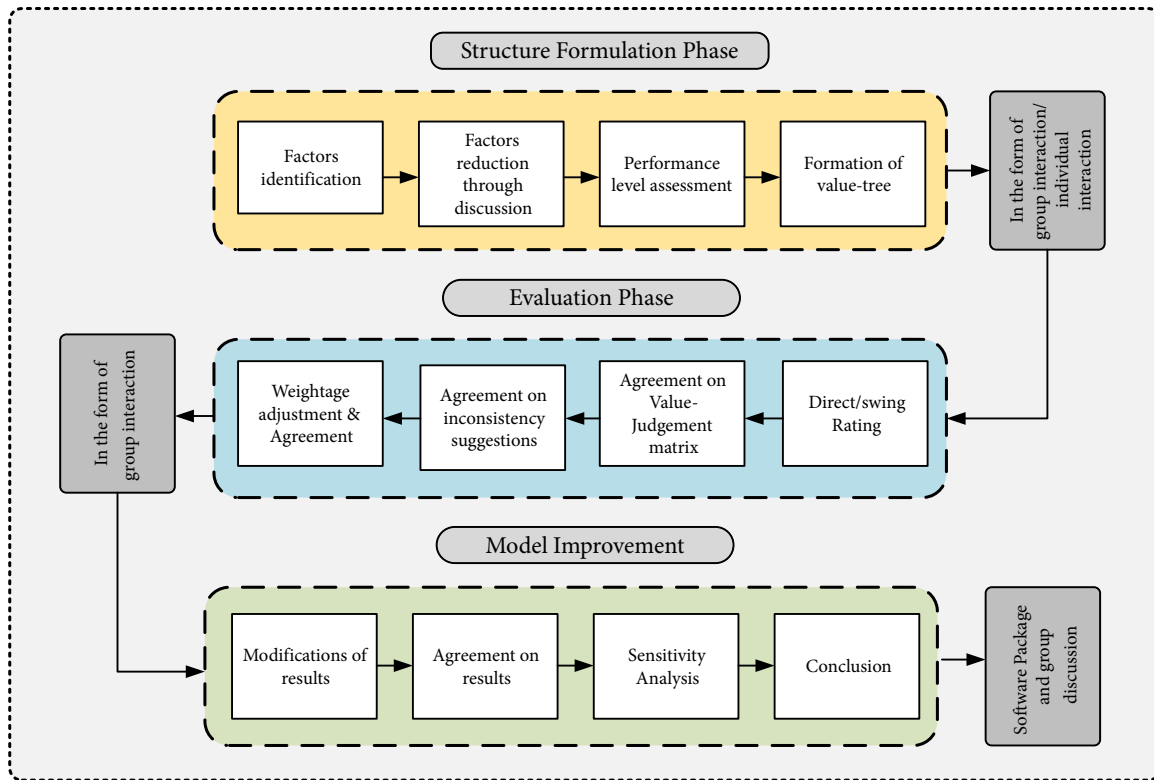

Figure 2. Embedded group decision-making process in classical MACBETH

4. Proposed formulation process of embedded remote group decision making system with MACBETH modification

MACBETH operates on a systematic three-tier process. The proposed system explained the modified embedded group decision-making system in MACBETH analysis as follows called as Embedded Remote Group Decision Making System. This system consists of groups of DMs that are not available at a single platform either physically or on the web to formulate problem structure, evaluate, offer their common judgment, and avoid diverse judgment from individual responses.

The first step in MACBETH is the structuring phase which is accountable for element formulations (i.e., attributes identification) and attributes' ratings. In classical MACBETH, a group of DMs allocates a task of formation of the structure model. However, this study presents an alternative solution where the facilitator (researcher) must substantially play their part. With the support of distant DMs, the facilitator itself can design a model structure rather than entirely relying on DMs. In this regards, the primary data set is traced to various prominent data sources in the form of literature unfolding, followed by experts' survey. A systematic review of literature assists in formulating the fundamental ideas of the associated problem. The facilitator identified criteria and later classified into a unique set of hierarchy (elements of MACBETH analysis). The classification critically made, and later its hierarchy was kept under focus. The final decision of the hierarchy and further the classification was based on ex-

perts' opinions.

The elements of MACBETH were designed in two separate questionnaire surveys (first survey: for element rating; second survey: pairwise format for computing weightage). In a survey kind of research, the role of the experts is immensely imperative. These kinds of researches anticipate the right guidance of relevant experts and further depend on their exchange of ideas entirely or partially. This study did not afford to have all experts at the same schedule and also confronted the difficulty of interacting with all experts at the same platform. Because of inconvenience in forming an embedded group decision environment, separate meetings were arranged with different experts in the form of face-to-face, and online methods (video and audio calls). In the beginning, the literature mapped groups of attributes were sent to each expert online, a couple of weeks before the discussion. Thus, a couple of days are provided to each expert to carefully review: i) criteria and sub-criteria, ii) proper classification of sub-criteria into appropriate criteria cluster, and iii) to decide the hierarchal orders of categories of criteria. Experts were authorized to remove, add or alter the attributes and classification as per their knowledge.

The second step in MACBETH analysis is the evaluation stage. The evaluation phase of classical MACBETH is responsible for attributes' rating and weightages. This accomplishes through a value judgment matrix acquire from DMs that precedes to an additive value model. In other words, at this stage, the ordinal information (i.e., ratings of attributes) transformed into cardinal information (differences of attractiveness) with the aid of Condition 2 of

MACBETH linear programming. In the proposed approach, the Condition 1 of MACBETH's linear programming was theoretically satisfied through Exploratory Factor Analysis (EFA). The EFA is a prominent data analysis method that applied to a set of observed variables seeking to find underlying factors (subsets of variables) that generate observed variables. This streamlined data analysis technique deals while extensive data is available for variables in many different sciences (Russell & Skibniewski, 1990). For the present case, EFA was executed using SPSS that supports a wide-ranging service for this analysis. In this study, the prime purpose of EFA is to replace the Condition 1 of MACBETH (i.e. computing ordinal information) which aims to facilitate the ranking as an alternative route to the classical MACBETH.

The final phase of MACBETH is model modification (i.e., Sensitivity Analysis). This stage is analyzed in M-

MACBETH software using a built-in function that is offered by M-MACBETH software. In many circumstances, the true essence of DMs' judgment does not reflect on such a priority scale (Bana e Costa et al., 2008) that is why the software offers the modifications of the priority scale to a specific prescribed limit. This modification of results is a tactic offered to DMs for altering their opinion regarding the attained weight. Because of psychological fluxes in DMs' decisions, the facilitators may deem the choice of sensitivity analysis in M-MACBETH software to compensate for the variations in decisions and further validate those. Thus, this analysis examines the variations that ensue in altering one attribute's weight to other attributes without altering the ranking. This offers a self-validation approach without the necessity of agreeing with all DMs. The proposed approached is graphically explained in Figure 3.

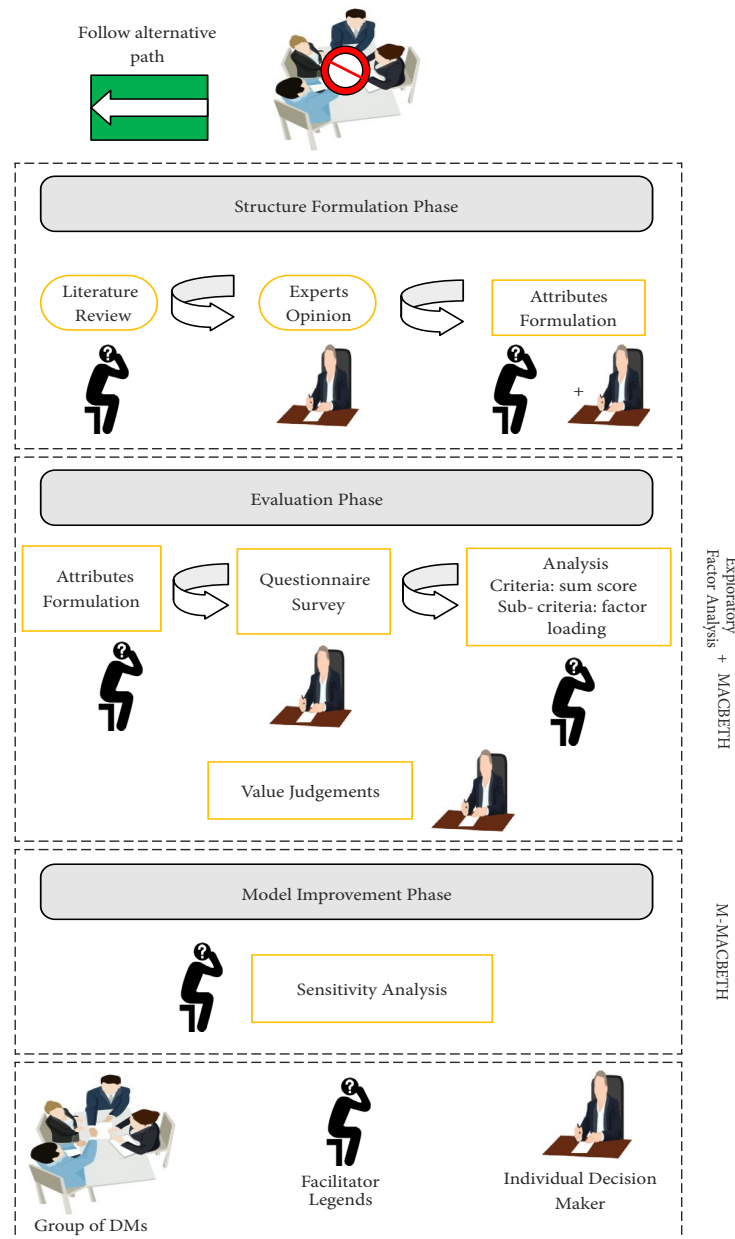

Figure 3. Proposed Embedded Remote Group Decision Making System

5. Application of proposed Embedded Remote Group Decision Making System in contractor selection

5.1. Structure formulation phase

The essential strides for this research are in the form of contractor selection in construction projects; therefore, a large number of past studies focused on enlisting the most useful set of extensive criteria. A novel classification of criteria is configured, keeping in view the demand for extensive contractor's selection nowadays based on previous studies mapping. After systematically examining the literature, the information from each expert was assembled and meticulously scrutinized later. With the experts' opinions, 76 attributes are divided into three categories, and 19 major criteria are organized. The classification is exceptional in many terms such as: 1) extensive classification of attributes, 2) appropriateness of sub-criteria among suitable criteria, and 3) three novel hierarchal categories. The attributes' design leads to the formulation of two separate but interconnected questionnaire surveys: first, for rating the attributes and second to know the level of attractiveness.

5.2. Evaluation phase

The attributes rating was performed via an alternative rating approach using EFA instead of direct or swing rating approach. Therefore, a few screening statistical examinations generally performed to authenticate data samples while applying the EFA. For instance, it is essential to examine the correlations among the variables and measure data strength. In the preliminary phase, the significance of the correlation matrix was analysed. This would clarify whether the factoring of the variable is significant for the EFA or not. An extensively and most prominent test for this purpose, which calculates the correlation matrix in terms of the identity matrix, is known as Bartlett's Sphericity test (BST). This test is based on the Chi-square coefficients and measures the intercorrelations among the factors. In other words, this test reveals the difference between the expected and observed covariance matrices. In this test, a Chi-square value equal to or less than 0.05 yields a satisfactory result.

Apart from the correlation of variables, another screening of data is required to examine the data adequacy for EFA. In this regard, Kaiser-Meyer-Olkin (KMO) evaluates the adequacy of the sample. It offers information concern-

ing the degree of common variance in variables that can help decide the appropriateness of data. A standard value of KMO lies between 0 to 1, where any value closer to 1 means that the data samples have compact relations, and favourable results are attainable in EFA. KMO value of 0.6 is considered a benchmark for further analysis (Foster et al., 2006; Tabachnick & Fidell, 2007). For the present case, Table 3 illuminates the screening test results for contractor selection attributes.

EFA offers a simple structure of attributes through a factor loading (FL) process. The FL can be obtained directly from a function available in SPSS known as Factor Rotation. The rotation method helps in inspecting the correlation coefficients correctly. A larger value of FL signals a closer relationship and offers a higher impact. A value of 0.5 and above is contemplated for a significant variable (Khoso et al., 2021a; Phogat & Gupta, 2019). A great variety of rotation methods are available in SPSS which mainly depend on the type of data, such as inter-relationships. However, the varimax method of orthogonal rotation is employed in present case. The factor rotation method yields factor loading through which the attributes were extracted. Besides the FL, a term Sum Score (SS) in the form of *factor score* calculated for each group (criteria) in order to rank the major criteria.

One of the many objectives of EFA in the past is to rank the factors (groups of subsets), where the factor indicates the major criteria and subsets means the sub-criteria. For this persistence, SS that may interchangeably use as factor score employed in various studies cited by DiStefano et al. (2009) and Khoso et al. (2021a). The factor with the most substantial value is positioned at the apex in the hierarchy, and the SS or FS values epitomize each group's essence (Benson et al., 2016). These values assist the researchers in envisaging the direct effects of individual scores on each group.

The attributes' rating is followed by weightages computation in MACBETH. For this purpose, a value tree of the model is formed in M-MACBETH, as shown in Figure 4. The value tree model represents a sort of hierarchical order of major and sub-criteria, along with the categories of criteria. Furthermore, it represents the entire structure and classification of attributes. For each set of attributes, different value judgment matrices are generated. In the beginning, two anchor values called performance levels are assigned from a by-default function, i.e., 0 to lower, and 100 to the upper limit. The categories of criteria, major criteria, and sub-criteria are subjected to judgments

Table 3. Bartlett's Test of Sphericity and KMO test results

		Critical criteria	Value-added criteria	Desirable criteria
Bartlett's Test of Sphericity	Approx. Chi-Square	1884.981	2145.282	1203.218
	df	496	378	120
	Sig.	0.000	0.000	0.000
Kaiser-Meyer-Olkin Measure of Sampling Adequacy		0.710	0.809	0.809

on a seven-point semantic scale. The 15 decision-makers (DMs) corresponded individually to offer their opinion on each set of data on the semantic scale. The separate information from each DM on each set of data is accumulated and recorded in SPSS. The gathered information from each DM then subjected to frequency analysis in terms of median values. This practical idea of assessing a compiled result from different groups of experts in case of non-availability of all experts at the same time is suggested by Mateus et al. (2017). When the final judgments is inserted in each case and pairwise matrices are generated, a few consistency issues are raised up which were later resolved with the support of M-MACBETH's by default judgment suggestion function. Each time when DM incorporates the judgment, the formulation tested, and auto-consistency is verified, and the suggestions are auto offered from the software (see Figure 5). The up and down direction of arrows suggests that the judgement from DMs on semantic scale requires to be modified either via increasing the scale value (upside arrow) or lowering the scale value (downside arrow).

Once the model is tested for inconsistencies and issues are proposed, computation of attributes' weight evoked. The process of obtaining the differences of attractiveness is followed systematically in stages, i.e., criteria categories, major criteria, and sub-criteria assessed pairwise using the difference of semantic attractiveness scale. A MACBETH interval scale generated initially employing linear programming conditions based on the judgments and number of attributes. Corresponding to the priority scale, the weights of attributes generated after agreement on the priority scale. The weights precisely interconnected with the priority scale, hence any modification in the priority scale, depending upon the requirement, would result in a modification in weights.

A top-down scheme of analyzing the weights was embraced further in the hierarchical weight system of M-MACBETH (beta version). In the earliest phase, categories of criteria, i.e., Critical Criteria, Value-added criteria, and Desirable criteria, were analyzed. A similar process was applied to major criteria in each category, and finally, the sub-criteria are weighted. At this stage, the results are analyzed in terms of MACBETH priority scales and weights. Table 4 shows the calculated weights for criteria categories in M-MACBETH. A similar process is followed for major criteria of each category, i.e., critical criteria, value-added criteria, and desirable criteria. Figure 6a and Figure 6b exemplified the priority scale and weights of critical criteria calculations in M-MACBETH software before and after modifications.

Table 4. Initial and current weights of contractor selection categories

Contractor's selection categories	Initial scale	Initial weight	Current scale	Current weight
Critical criteria	100	58.33	100	50
Value-added criteria	57.14	33.33	60	30
Desirable criteria	14.29	8.34	40	20

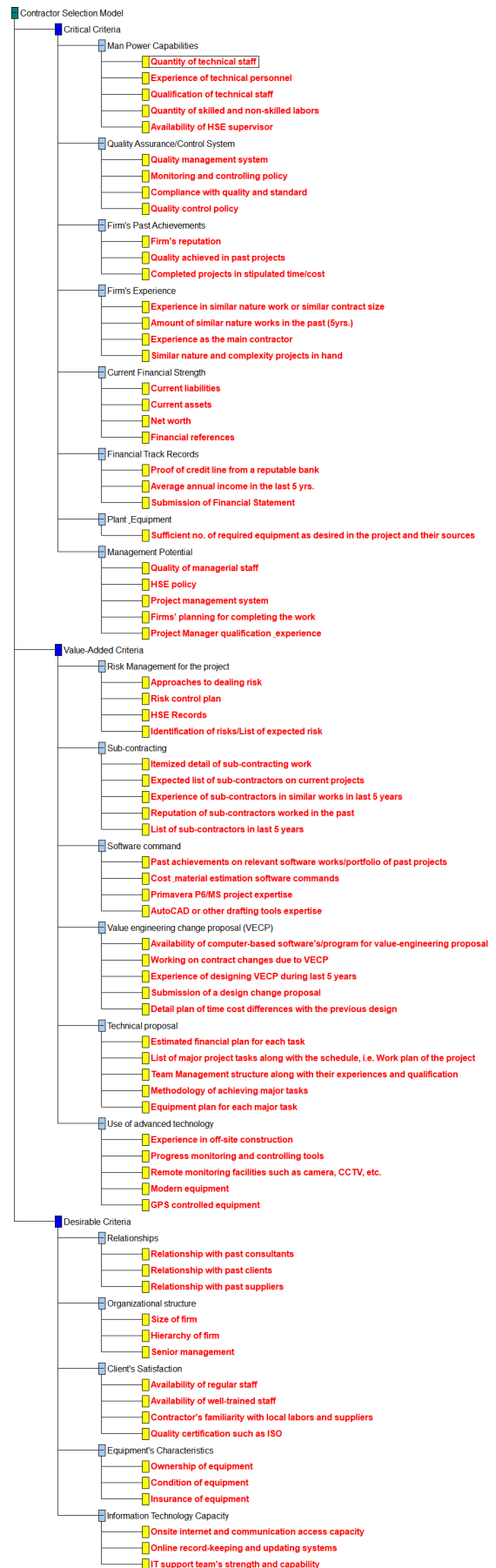

Figure 4. Value tree of model

Value-Added Criteria							
	[RM]	[SC]	[SWC]	[VECP]	[TP]	[AT]	[all lower]
[RM]	no	moderate	weak	weak-mod	moderate	moderate	positive
[SC]		no	weak	weak	moderate	moderate	positive
[SWC]			no	weak	moderate	moderate	positive
[VECP]				no	moderate	moderate	positive
[TP]					no	moderate	positive
[AT]						no	positive
[all lower]							no

Inconsistent judgements
Suggestion 1 of 2 : 1 modification(s)

Figure 5. Consistency suggestion in M-MACBETH

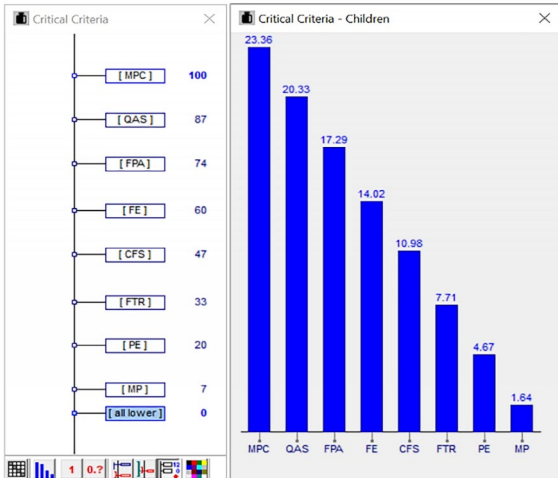

Figure 6a. Initial priority scale and initial weight of major criteria of critical criteria category

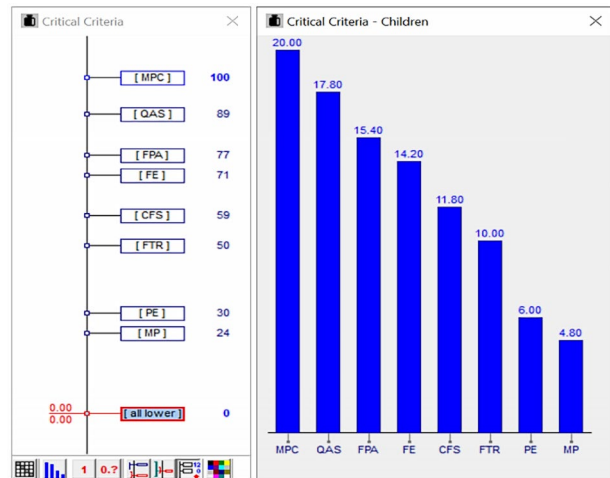

Figure 6b. Current priority scale and current weight of major criteria of critical criteria category

The necessary modifications are performed in M-MACBETH software via modifying the priority scale which helps in changes the criteria weight.

In Figure 6a, the initial weights of criteria stand for exceedingly low values in the last three criteria, i.e., “financial track record” (FTR), “plant and equipment” (PE), and “management potential” (MP). This triggers the further assessment problem in sub-criteria of these major criteria, and to divide the weight percentages into sub-criteria would be a matter of concern. Moreover, owing to exceedingly smaller values, the contractors would not upkeep these criteria, and real multi-criteria selection would be rather worthless. In order to circumvent these problems, the initial scale adjusted so that the fair current weights can be attained. In this continuation, the weight of MP increased from a value of 1.64 to 4.8 (rounded off to 5). Similarly, for PE, the weight is improved from 4.83 to 6, and so other weights are modified accordingly (see Figure 6b). All modified weight values are rounded to the nearest whole number later.

Similar to the critical criteria, the judgments for the value-added criteria and desirable criteria are tested and analysed. A similar situation confronted throughout the analysis that the last criteria of value-added category, i.e., “use of advance technology” (AT), obtained exceedingly lesser value, i.e., 1.52. An identical adjustment process followed, and current weights were calculated. Likewise, the

analysis of desirable criteria also emanated into a similar situation. The “information technology capacity” (ITC) attained a value of 3.33, which is challenging to distribute among subsets, and the “relationship” (RS) criteria received very high value, i.e., 36.67. This non-uniform distribution of weight altered using an identical process and the values of the weights are revised.

In the final phase of top-down hierarchical order structure, the calculated weight of sub-criteria in each major criterion category was calculated by employing a similar approach. The critical criteria category comprises of 29 sub-criteria divided into eight major criteria, whereas, the value-added criteria category consists of 28 sub-criteria divided into six major criteria, and the desirable criteria are organized among five major criteria and 16 sub-criteria. The value judgments from the DMs added into the M-MACBETH software and subsequently tested and validated. The same modifications in the priority scale and weights followed in computing the final priority scale and weight. In all the cases, a uniform condition was confronted, i.e., problem in the weights of outliers. The top-ranked sub-criteria received exceptionally high value, whereas the lower-ranked sub-criteria attain exceedingly lesser value, which is challenging to assess and distribute to further lower-order hierarchy.

The attained weight of criteria categories, major criteria, and their sub-criteria calculated in the first round.

However, the distribution of weight to their children (sub-criteria) is yet to be addressed. The underlying purpose of computing the distribution values to their children is to compute each parameter’s global weight. Each major criterion category’s total sum is 100, similar to the total sum of sub-criteria weight and global weight. Thus, the global weight is another interpretation of sub-criteria weight that demonstrates the values after distribution according to their weights from clusters to sub-clusters and later to super sub-clusters (as shown in Figure 7).

Figure 7 illustrates the concept of weight distribution. Here “xC” represents the type of criteria category, and “xCA” represents its corresponding criteria, and “Z%” indicates the distribution percentages (weights in the form of percentages). The flow of percentages facilitates in computing the global weight of each sub-criteria (i.e., sub-cluster). The distribution weights values thus calculated with simple percentages multiplication with top-down weights distribution. The outcome of the model of the weight illustrated in Figure 8 in the form of a value tree model.

The derived model DSMCS (decision system of multi-criteria selection) in Figure 8 has three hierarchal levels, i.e., category, criteria, and sub-criteria. According to Figure 7, the weights are distributed via a top-down hierarchal levels. The three categories in Figure 8 organized into main and sub-criteria – the percentage distribution method followed in computing the model’s outcome. The numerical values on the top left side of each category of criteria represent the category’s weight. The category weight helps in deciding the sub-cluster and super sub-cluster weightages. Similarly, the weight of major criteria and sub-criteria are exemplified at the left side of each parameter, whereas, the right-side values of each sub-criteria represent the super-sub cluster values, i.e., after applying the distribution percentages.

5.3. Model improvement phase

A MACBETH priority scale is produced in the beginning afterwards analyzing the judgments and the consistencies. Individual variations among the priority scale was obtained while confirming the attributes’ weight (see Figure 9 for the case of desirable criteria). There is a more considerable change observed in initial and current priority scales in case of RS (Relationship) and OS (Organizational Structure) criteria and similarly, in the last two criteria, i.e., EQ (Equipment Characteristics) and ITS (Information Technology Capacity).

Figure 9 clarifies that EQ’s criterion has an initial scale of 36.36 (left side of Figure 9) and later modified to 51.84 (right side of Figure 9). With a quotation to modification in a specific criterion, the MACBETH self-adjusts the corresponding scale limits for all other criteria accordingly. A similar interactive process followed for all the enduring attributes. Following the initial weights’ calculations while employing the initial priority scale, the modified weights called current weights determined for each case. The current weight derives from the modification of the priority

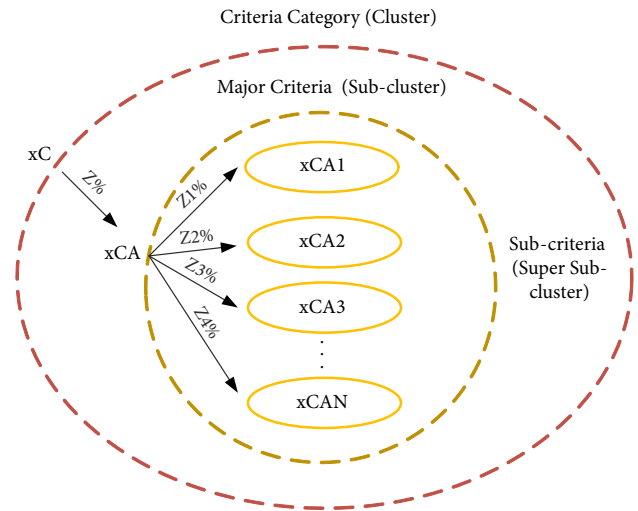

Figure 7. Schematic diagram showing weights distribution

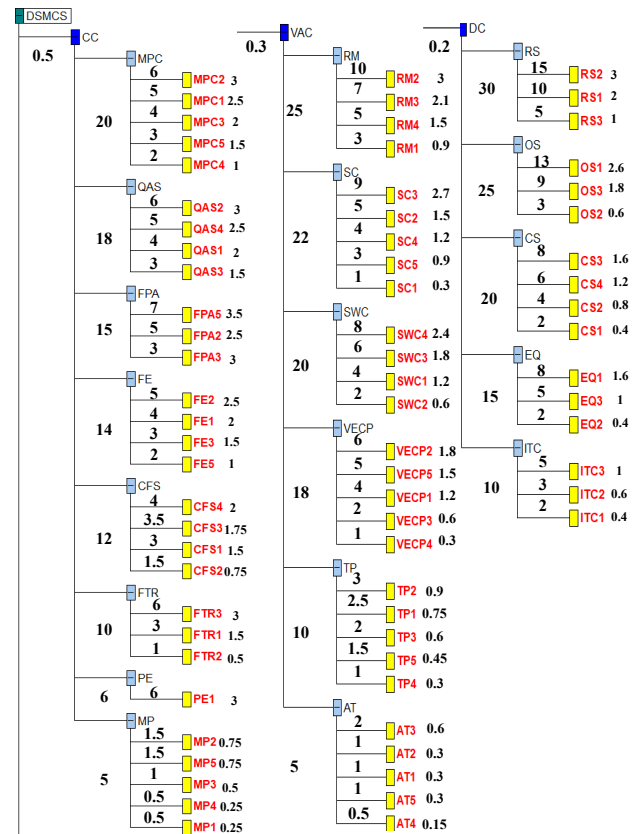

Figure 8. Weight model in M-MACBETH

scale to a certain extent. Thanks to M-MACBETH’s built-in function that offers lower and upper limits of criteria weight retaining the DMs judgment unaffected. Fundamentally, the modifications in the current scale accomplished to increase smaller values of specific criteria. This alternation supports achieving a straightforward weight distribution to its sub-criteria, and the comprehensive assessment is simply possible for the clients while evaluating the competitors in the tendering process. This modification in attained weights was endorsed by Bana e Costa et al. (2008), according to which very small weights in certain

criteria trigger problems for evaluators. Therefore, the initial weights modified within the prescribed limits without altering the DMs judgments in the sensitivity analysis. A distinct process of sensitivity analysis was performed in the iterative process. Since each attribute has an implication, MACBETH's inherent drawback lies in outliers' weight, i.e., if one of the attributes is weighted high, the other (especially the last from the group) weights too low. Here, the attributes' weight is adjusted accordingly, so that outliers are modified consistently, i.e., none of the attributes weigh too low or too high. This is enormously essential, especially in a contractor's selection where each attribute has significance while deciding the competitive partner. Henceforth, a careful iterative process followed to adjust the weight of all the attributes satisfying contractor selection. The modifications of scale and weights in different attribute groups (sensitivity analysis) can be observed in Appendix 1.

In Appendix 1 (Figures A1–A22), the initial scale and initial weight were established over DMs' value judgments. In the majority of cases, the obtained weights are not consistent (as some of them are highly weighted and vice versa). Keeping in mind that the modification process does not alter the attributes' ranks, but only the weights are modified owing to the inappropriateness of the obtained weight. This leads to modification of the initial scale to the current scale that correspondingly alters the weights, called current weights. The modified model can be validated from the DMs group because the final shape of the model is different from what the software produced. However, one must keep in mind that the modified model based on the software without compromising the other attributes and DMs' judgments. The suggested flexibility in the priority scale and weights is a by-product of this investigation. The additional analysis may require further discussion with experts. The facilitators would decide the outcome after individual meetings conducted with each expert, either one-on-one or via emails or other online choices. Thus, it is imperative to underline that this type of analysis is carried out to determine the model's stability.

6. Discussion on proposed Embedded Remote Group Decision Making System

MACBETH has multiple advantages ranging from measuring the attractiveness on a qualitative scale to its self-consistency judgments, modifications, and validation. It entails little efforts equally to the experts (DMs) and facilitators. DMs require no additional exercise to rate and compare the attributes as those measures on a simple scale. Facilitators also deem gratifications as no additional hardship necessitated to explain the method to DMs. The process of ordinal information (ratings) is easily transformable into cardinal information (level of attractiveness).

This research implements a novel concept of remote group decision via a case of contractor selection in construction. The case of contractor selection involves multiple sets of sophisticated attributes, and here the model size also enlarges with increasing attributes. Besides, to deal with a more extensive set of attributes, inviting the DMs to investigate the subject on the same platform remained a concern for many researchers. A group environment to explore for a complex problem is a piece of exceeding demand. However, the arrangement of experts at the same platform simultaneously is a common problem for many researchers. Nonetheless, this proposed system investigated the insight of dealing with the MACBETH without having a larger group at the same platform called remote group environment. In classical MACBETH, a group of experts sits at the same platform in several rounds, where each round takes a couple of hours. In the beginning phase, a collective process of listing out the attributes begins. This is perhaps the most challenging phase for DMs to develop relevant attributes with prolonged discussion with others. Another matter of attraction in the present investigation lies in augmenting the role of facilitator. In the classical approach complete process is founded on the shoulders of DMs where the facilitator has no option other than to accept and welcome the ideas and decisions from DMs. In contrast, a facilitator may unfold relevant literature attributes as several sources are available to explore the attributes. This can be followed so that the facilitator shares the information to each DMs individually and allows them sufficient time to work out other relevant attributes rather than pressurizing them in a limited time group discussion. The facilitator assumes to work hard to come up with final attributes with the consent of all DMs. This process may be served as an alternate to the first phase of MACBETH, i.e., structuring the model.

In the classical MACBETH process, the second phase of group discussion begins in the form of multiple judgments and agreeing on a single decision to construct a single value judgment matrix. In many cases, this creates conflicts among DMs as it is hardly possible to accept all DMs' opinion. In some instances, some outlier decisions may generate in the form of extreme differences and imbalance ideas. However, regardless of all, a single decision is forcibly carried irrespective of all DMs' accep-

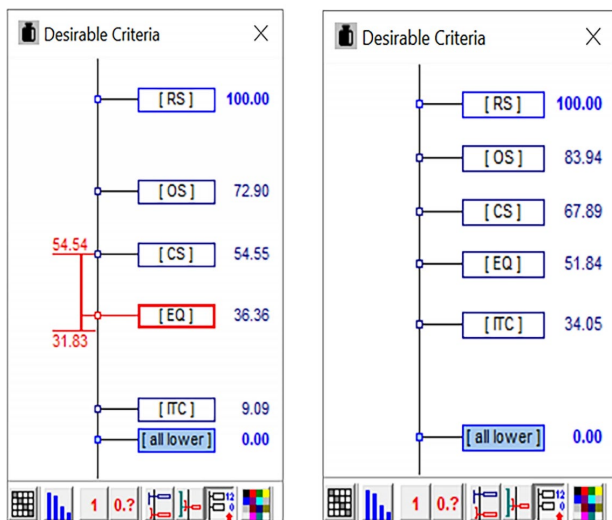

Figure 9. Modifications in MACBETH priority scale

tance. This process followed by rating the attributes using a direct swing or swing weight method, as in the case of the classical SMART technique. The classical rating approach applied in MACBETH criticized in many aspects of literature. Due to several drawbacks in the swing rating method, various upcoming studies are modifying the old rating method. Despite several shortcomings in the classical rating method, the MACBETH is still based on these outdated methods of attributes' rating. In addition to this, the problem with the direct and swing rating method multiplied in a larger set of attributes (as in our case, we have 73 attributes). The irrational method of rating the attributes would worsen on more extensive attributes when all DMs' opinion has to be respected. The prolonged discussion could involve several hours of discussion to decide an aggregate rating of all attributes. The conventional approach requires a pairwise comparison of attributes for their ranking. This proposed system helps in eliminating such classical approaches and insinuates that a most entrusted and prominent EFA method may be adopted. Here the group discussion is no longer essential as several means such as sample requirement, internal consistency, KMO, and Bartlett's test of sphericity already confirm the data validity in different facets. Another advantage of integrating EFA is involving the larger group of participants to make up the process more trustful. Each participant can communicate to participate individually via face to face interaction or through various online sources such as Google forms, emails, WhatsApp audio/video calls, etc.

The process of ratings the attributes (i.e., ordinal information) further requires transferring in cardinal information to measure the attractiveness between each pair of attributes on the seven-point semantic scale. In the classical MACBETH approaches, this process was carried out through a group discussion where all DMs have to agree on the same level of attractiveness from "no difference" to "extreme difference" on a scale. The process returns to all attributes, and each time judgment is verified and checked for consistency. Another matter of argument is the agreement on a particular judgment when there are many brains involved. It is possible and advantageous in many cases but not in all, especially those that are involved with more significant pairs of attributes. In our case, there were 170 pairwise comparisons, and the process of embedded group decision making could be elongated to a couple of hours with no guarantee of agreement on the same decision. In contrast, an individual process of holding judgments from all DMs can be a solution and the right direction. All DMs' judgment may be analyzed in any software, for example, SPSS (a standard statistical analysis tool). Different approaches to computing average mean median or mode methods can be applied easily. Without reinventing the wheel, the process of the median is adopted owing to its accuracy over other methods, as evidenced by Mateus et al. (2017). Further discussion, appropriateness, and validity of the method can be referred therein. Consistency of method is already ascertained using an auto-consistency check, thanks to M-MACBETH software.

The last stage of model improvement indeed does not require all DMs on a single platform. M-MACBETH offers two essential functions of sensitivity analysis and robustness as a built-in function. The suitable ranges offered in the software in order to modify the computed weight do not alter DMs' judgment. This useful tool helps the facilitator to modify the weights according to the subject of the research question. A similar case of contractor selection investigated here where too small values in the last ranked attribute do not justify the assessment process. The facilitator thus has the mandate to modify the weight within the prescribed limits offered by the software. Consequently, the problem of modifying the weights can fix through the software's assistance without arranging a meeting of experts (as in the case of classical approaches). However, the verification of modified weight could be accomplished through an individual communication with each expert, either physically or online. The final recommendations, therefore, can be made with the consent of all involved DMs. Furthermore, the robustness of the model could help facilitator to demonstrate the model strength.

The proposed embedded remote group decision-making system could improve the MACBETH in various directions. Apart from numerous perks of group decision making, its execution at the required time and platform was deemed as an impediment in the research. The decisions that were entirely made on the mercy of DMs are turned into a new phase that does not allow forcible DMs decisions. In addition, the opinion of all DMs is now respected and provided equal weightage. Further, the proposed approach could assist in executing research with or without having an embedded group discussion at the same platform either physically or on the web. The integration of EFA in MACBETH turned the weaknesses into opportunities. The confrontation among researchers on the Condition 1 of MACBETH has a new direction. The facilitator could feel higher confidence in conducting the research as it does not require arranging a DMs platform. Undoubtedly, the applications of MACBETH would also boost.

7. Implication and limitation of the system

The embedded remote group decision-making system in MACBETH has numerous advantages from various directions. It is limited to MACBETH; however, due to its versatility, a similar approach is fruitful for other group-related environments involving collective decisions. The system respects the idea and knowledge of all involved DMs in a novel way. From a facilitator's views, this system helps to carry out their research without confusing in embedded group decision environment but including all DMs in the model. It further encourages them to explore their own experience, ideas, and judgments for developing such complex models. With this, complex problems of embedded group decision making could resolve efficiently. The discussion mentioned above supports the fact that the implementation of MACBETH is possible with a remote group decision environment. However, the ap-

proach never means to discourage DMs' single platform; instead, this offers alternative directions for conducting similar research.

The other side of the model's implication is for the project stakeholders, i.e., clients (owners of projects). An application of the model for the most crucial issue of all the time, i.e., selecting contractors, exhaustively explained in the model. The novel classification of selection criteria is another by-product of this research. The identified criteria explored through detail analysis, and experts' discussions can be recommended in a real problem. Furthermore, the implemented idea of contractor selection would assuredly support discovering other avenues of research in the MACBETH group decision process.

The developed system of a remote group environment would achieve very encouraging results. However, besides the developed approach's versatility and flexibility, the system is considered a pioneering method. Thus, the path of achieving the optimal results is still unpaved and yet to explore. However, this can further be sustained through full-scale mathematical modelling and further comparing the results with group decision making. A full-scale case study is another way forward to validate the findings. A critical focused group discussion would be fruitful in this regard. Since the study is premier of its type, further research avenues could be explored in the near future.

Conclusion and future study directions

The present study aims to investigate an approach alternate to dealing with embedded group decision problems on the same platform in case of the MACBETH technique. In addition, this investigation aims to redesign the rating process of classical MACBETH in an attempt to modify the MACBETH. This inquiry has provided alternate solution techniques at each phase of group decision in MACBETH. Exploratory Factor Analysis instead of a direct or swing rating approach proposed to rank the attributes. The research offers a novel and premier method of dispensing the MACBETH technique in a remote environment. A case of contractor selection is supported and implemented to understand the proposed alternative system. As an additional finding, the concept of extensive contractor selection is proposed where attributes are divided into different groups. This extensive classification of attributes improves the problem of competitive contractor selection in the construction sector. In summary, the study unveils that hurdles of embedded group decision making at a single platform could have an alternate solution. Furthermore, the outdated method of attributes' rating can exchange through the integration of another method such as EFA. This research envisaged to serve as a base for several studies in the future as the method could be implemented to other relevant cases of embedded group decisions in other MCDM techniques and real scenario problems. The current research has made some noteworthy contributions to the body of knowledge through a roadmap provided as alternatives to the embedded group decision process.

Moreover, the integration of EFA into MACBETH is another novel contribution leading towards the exploration of other more suitable methods. This work has opened up several investigations for future purposes. As an extension to this work, detailed and exploratory research may be required in the future to compare the results with a classical and modified method of remote group decision environment. The integration of other rating techniques in MACBETH is another opportunity that would open several avenues of novel research.

Data availability statement

All data, models, and code generated or used during the study appear in the submitted article.

Acknowledgements

This work was supported by the National Natural Science Foundation of China under Grant nos. 72171182, 71801175, 71871171, 71971182, and 72031009, the Theme-based Research Projects of the Research Grants Council (Grant no. T32-101/15-R), the Ger/HKJRS project (grant no. G-CityU103/17), and partly by the City University of Hong Kong SRG (Grant no. 7004969).

Author contributions

Ali Raza Khoso: Conceptualization, Methodology, Investigation, Writing – Original draft, Formal analysis, Validation, Visualization; Aminah Md Yusof: Investigation, Writing – Reviewing and Editing; Zhen-Song Chen: Writing – Reviewing and Editing, Funding acquisition, Project Administration; Xian-Jia Wang: Writing – Reviewing and Editing, Funding acquisition; Mirosław J. Skibniewski: Writing – Reviewing and Editing; Nafees Ahmed Memon: Writing – Reviewing and Editing.

Disclosure statement

The authors declare that they have no known competing financial interests or personal relationships that could have appeared to influence the work reported in this paper.

References

- Anagnostopoulos, K. P., & Vavatsikos, A. P. (2006). An AHP model for construction contractor prequalification. *Operational Research*, 6(3), 333–346. <https://doi.org/10.1007/BF02941261>
- Andrade, G. N., Alves, L. A., Andrade, F. V. S., & de Mello, J. C. C. B. S. (2016). Evaluation of power plants technologies using multicriteria methodology MACBETH. *IEEE Latin America Transactions*, 14(1), 188–198. <https://doi.org/10.1109/tla.2016.7430079>
- Awwad, R., & Ammouy, M. (2019). Owner's perspective on evolution of bid prices under various price-driven bid selection methods. *Journal of Computing in Civil Engineering*, 33(2), 04018061. [https://doi.org/10.1061/\(ASCE\)CP.1943-5487.0000803](https://doi.org/10.1061/(ASCE)CP.1943-5487.0000803)

- Bachrane, M., Khaled, A., El-Alami, J., & Hanoune, M. (2016). Investment location selection based on economic intelligence and MACBETH decision aid model. *Journal of Information Technology Research*, 9(3), 37–48. <https://doi.org/10.4018/jitr.2016070103>
- Bana e Costa, Carlos A., & Vansnick, J. C. (1994). MACBETH – An interactive path towards the construction of cardinal value functions. *International Transactions in Operational Research*, 1(4), 489–500. [https://doi.org/10.1016/0969-6016\(94\)90010-8](https://doi.org/10.1016/0969-6016(94)90010-8)
- Bana e Costa, C. A., Corrêa, Ê. C., De Corte, J. M., & Vansnick, J. C. (2002). Facilitating bid evaluation in public call for tenders: A socio-technical approach. *Omega*, 30(3), 227–242. [https://doi.org/10.1016/S0305-0483\(02\)00029-4](https://doi.org/10.1016/S0305-0483(02)00029-4)
- Bana e Costa, C., De Corte, J.-M., & Vansnick, J.-C. (2003). MACBETH (Overview of MACBETH multicriteria decision analysis approach). *International Journal of Information Technology and Decision Making*, 11(1), 359–387. <https://doi.org/10.1142/S0219622012400068>
- Bana e Costa, Carlos A., & Chagas, M. P. (2004). A career choice problem: An example of how to use MACBETH to build a quantitative value model based on qualitative value judgments. *European Journal of Operational Research*, 153(2), 323–331. [https://doi.org/10.1016/S0377-2217\(03\)00155-3](https://doi.org/10.1016/S0377-2217(03)00155-3)
- Bana e Costa, C. A., De Corte, J. -M., & Vansnick, J. -C. (2005). On the mathematical foundation of MACBETH. In J. Figuiera, S. Greco, & M. Ehrgott (Eds.), *Multiple criteria decision analysis: state of the art surveys* (pp. 409–442). Springer Science & Business Media. https://doi.org/10.1007/0-387-23081-5_10
- Bana e Costa, C. A., Oliveira, C. S., & Vieira, V. (2008). Prioritization of bridges and tunnels in earthquake risk mitigation using multicriteria decision analysis: Application to Lisbon. *Omega*, 36, 442–450. <https://doi.org/10.1016/j.omega.2006.05.008>
- Bana e Costa, C. A., Carnero, M. C., & Oliveira, M. D. (2012). A multi-criteria model for auditing a Predictive Maintenance Programme. *European Journal of Operational Research*, 217(2), 381–393. <https://doi.org/10.1016/j.ejor.2011.09.019>
- Barfod, M. B., & Salling, K. B. (2015). A new composite decision support framework for strategic and sustainable transport appraisals. *Transportation Research Part A: Policy and Practice*, 72, 1–15. <https://doi.org/10.1016/j.tra.2014.12.001>
- Benson, N. F., Kranzler, J. H., & Floyd, R. G. (2016). Examining the integrity of measurement of cognitive abilities in the prediction of achievement: Comparisons and contrasts across variables from higher-order and bifactor models. *Journal of School Psychology*, 58, 1–19. <https://doi.org/10.1016/j.jsp.2016.06.001>
- Bernard, H. R. (2006). *Research methods in anthropology* (2nd ed.). Lanham.
- Birjandi, A. K., Akhyani, F., Sheikh, R., & Sana, S. S. (2019). Evaluation and selecting the contractor in bidding with incomplete information using MCGDM method. *Soft Computing*, 23(20), 10569–10585. <https://doi.org/10.1007/s00500-019-04050-y>
- Carnero, M. C., & Gómez, A. (2016). A multicriteria decision making approach applied to improving maintenance policies in healthcare organizations. *BMC Medical Informatics and Decision Making*, 16(1), 47. <https://doi.org/10.1186/s12911-016-0282-7>
- Chen, Z. S., Zhang, X., Pedrycz, W., Wang, X. J., & Skibniewski, M. J. (2020). Bid evaluation in civil construction under uncertainty: A two-stage LSP-ELECTRE III-based approach. *Engineering Applications of Artificial Intelligence*, 94, 103835. <https://doi.org/10.1016/j.engappai.2020.103835>
- Chen, Z. S., Zhang, X., Rodríguez, R. M., Pedrycz, W., & Martínez, L. (2021). Expertise-based bid evaluation for construction-contractor selection with generalized comparative linguistic ELECTRE III. *Automation in Construction*, 125, 103578. <https://doi.org/10.1016/j.autcon.2021.103578>
- Cheng, E. W. L., & Li, H. (2004). Contractor selection using the analytic network process. *Construction Management and Economics*, 22(10), 1021–1032. <https://doi.org/10.1080/0144619042000202852>
- Clivillé, V., & Berrah, L. (2012). Overall performance measurement in a supply chain: Towards a supplier-prime manufacturer based model. *Journal of Intelligent Manufacturing*, 23(6), 2459–2469. <https://doi.org/10.1007/s10845-011-0512-x>
- Cox, R., Sanchez, J., & Revie, C. W. (2013). Multi-criteria decision analysis tools for prioritising emerging or re-emerging infectious diseases associated with climate change in Canada. *PLoS ONE*, 8(8), e68338. <https://doi.org/10.1371/journal.pone.0068338>
- Dabrowski, M. (2014). The simple multi attribute rating technique (SMART). In *Multi-criteria decision analysis for use in transport decision making*. DTU Transport Compendium Series (Part 2).
- Danielson, M., & Ekenberg, L. (2019). An improvement to swing techniques for elicitation in MCDM methods. *Knowledge-Based Systems*, 168, 70–79. <https://doi.org/10.1016/j.knosys.2019.01.001>
- Darvish, M., Yasaei, M., & Saeedi, A. (2009). Application of the graph theory and matrix methods to contractor ranking. *International Journal of Project Management*, 27(6), 610–619. <https://doi.org/10.1016/j.ijproman.2008.10.004>
- Demesouka, O. E., Vavatsikos, A. P., & Anagnostopoulos, K. P. (2016). Using MACBETH multicriteria technique for GIS-Based landfill suitability analysis. *Journal of Environmental Engineering*, 142(10), 04016042. [https://doi.org/10.1061/\(ASCE\)EE.1943-7870.0001109](https://doi.org/10.1061/(ASCE)EE.1943-7870.0001109)
- DiStefano, C., Zhu, M., & Mindrilă, D. (2009). Understanding and using factor scores: Considerations for the applied researcher. *Practical Assessment, Research and Evaluation*, 14(20), 20. <https://doi.org/10.7275/da8t-4g52>
- Edwards, W., & Barron, F. H. (1994). SMARTS and SMARTER: Improved simple methods for multiattribute utility measurement. *Organizational Behavior and Human Decision Processes*, 60(3), 306–325. <https://doi.org/10.1006/obhd.1994.1087>
- El-Abbasy, M. S., Zayed, T., Ahmed, M., Alzraiee, H., & Abouhamad, M. (2013). Contractor selection model for highway projects using integrated simulation and Analytic Network Process. *Journal of Construction Engineering and Management*, 139(7), 755–767. [https://doi.org/10.1061/\(ASCE\)CO.1943-7862.0000647](https://doi.org/10.1061/(ASCE)CO.1943-7862.0000647)
- Elsayah, O. S. (2016). *A framework for improvement of contractor selection procedures on major construction project in Libya*. <https://www.napier.ac.uk/~media/worktribe/output-453191/a-framework-for-improvement-of-contractor-selection.pdf>
- Ertay, T., Kahraman, C., & Kaya, İ. (2013). Evaluation of renewable energy alternatives using MACBETH and Fuzzy AHP multicriteria methods: The case of Turkey. *Technological and Economic Development of Economy*, 19(1), 38–62. <https://doi.org/10.3846/20294913.2012.762950>
- Ferreira, F. A. F., Spahr, R. W., Santos, S. P., & Rodrigues, P. M. M. (2012). A multiple criteria framework to evaluate bank branch potential attractiveness. *International Journal of Strategic Property Management*, 16(3), 254–276. <https://doi.org/10.3846/1648715x.2012.707629>

- Ferreira, F. A. F., Spahr, R. W., & Sunderman, M. A. (2016). Using multiple criteria decision analysis (MCDA) to assist in estimating residential housing values. *International Journal of Strategic Property Management*, 20(4), 354–370. <https://doi.org/10.3846/1648715x.2015.1122668>
- Foster, J., Barkus, E., & Yavorsky, C. (2006). *Understanding and using advanced statistics*. SAGE Publications Ltd. <https://doi.org/10.4135/9780857020154>
- Gonçalves, J. M., Ferreira, F. A. F., Ferreira, J. J. M., & Farinha, L. M. C. (2019). A multiple criteria group decision-making approach for the assessment of small and medium-sized enterprise competitiveness. *Management Decision*, 57(2), 480–500. <https://doi.org/10.1108/MD-02-2018-0203>
- Gurbuz, T. (2010). Multiple criteria human performance evaluation using Choquet integral. *International Journal of Computational Intelligence Systems*, 3(3), 290–300. <https://doi.org/10.2991/ijcis.2010.3.3.5>
- Holt, G. (2010). Contractor selection innovation: Examination of two decades' published research. *Construction Innovation*, 10(3), 304–328. <https://doi.org/10.1108/14714171011060097>
- James, S. (2004). *The wisdom of crowds: Why the many are smarter than the few and how collective wisdom shapes business, economies, societies and nations*. Random House Large Print.
- Jaskowski, P., Biruk, S., & Bucon, R. (2010). Assessing contractor selection criteria weights with fuzzy AHP method application in group decision environment. *Automation in Construction*, 19(2), 120–126. <https://doi.org/10.1016/j.autcon.2009.12.014>
- Jato-Espino, D., Castillo-Lopez, E., Rodriguez-Hernandez, J., & Canteras-Jordana, J. C. (2014). A review of application of multi-criteria decision making methods in construction. *Automation in Construction*, 45, 151–162. <https://doi.org/10.1016/j.autcon.2014.05.013>
- Joerin, F., Cool, G., Rodriguez, M. J., Gignac, M., & Bouchard, C. (2010). Using multi-criteria decision analysis to assess the vulnerability of drinking water utilities. *Environmental Monitoring and Assessment*, 166(1), 313–330. <https://doi.org/10.1007/s10661-009-1004-8>
- Keeney, R. L., & Howard, R. (1993). *Decisions with multiple objectives: Preferences and value trade-offs*. Cambridge University Press. <https://doi.org/10.1017/CBO9781139174084>
- Khoso, A. R., & Yusof, A. M. (2020). Extended review of contractor selection in construction projects. *Canadian Journal of Civil Engineering*, 47(7), 771–789. <https://doi.org/10.1139/cjce-2019-0258>
- Khoso, A. R., Yusof, A. M., Chai, C., & Laghari, M. A. (2021a). Robust contractor evaluation criteria classification for modern technology public construction projects. *Journal of Public Procurement*, 21(1), 53–74. <https://doi.org/10.1108/JOPP-06-2020-0053>
- Khoso, A. R., Yusof, A. M., Khahro, S. H., Abidin, N. I. A. B., & Memon, N. A. (2021b). Automated two-stage continuous decision support model using exploratory factor analysis-MACBETH-SMART: an application of contractor selection in public sector construction. *Journal of Ambient Intelligence and Humanized Computing*. <https://doi.org/10.1007/s12652-021-03186-w>
- Khoso, A. R., Yusof, A. M., Chen, Z. S., Skibniewski, M. J., Chin, K. S., Khahro, S. H., & Sohu, S. (2021c). Comprehensive analysis of state-of-the-art contractor selection models in construction environment-A critical review and future call. *Socio-Economic Planning Sciences*, 101137. <https://doi.org/10.1016/j.seps.2021.101137>
- Konidari, P., & Mavrakis, D. (2007). A multi-criteria evaluation method for climate change mitigation policy instruments. *Energy Policy*, 35(12), 6235–6257. <https://doi.org/10.1016/j.enpol.2007.07.007>
- Kundakci, N. (2019). An integrated method using MACBETH and EDAS methods for evaluating steam boiler alternatives. *Journal of Multi-Criteria Decision Analysis*, 26(1), 27–34. <https://doi.org/10.1002/mcda.1656>
- Lam, K. C., & Yu, C. Y. (2011). A multiple Kernel learning-based decision support model for contractor pre-qualification. *Automation in Construction*, 20(5), 531–536. <https://doi.org/10.1016/j.autcon.2010.11.019>
- Lauras, M., Marques, G., & Gourc, D. (2010). Towards a multi-dimensional project performance measurement system. *Decision Support Systems*, 48(2), 342–353. <https://doi.org/10.1016/j.dss.2009.09.002>
- Liu, B., Huo, T., Meng, J., Gong, J., Shen, Q., & Sun, T. (2015). Identification of key contractor characteristic factors that affect project success under different project delivery systems. *Journal of Management in Engineering*, 32(1), 05015003. [https://doi.org/10.1061/\(ASCE\)ME.1943-5479.0000388](https://doi.org/10.1061/(ASCE)ME.1943-5479.0000388)
- Liu, B., Huo, T., Liao, P., Yuan, J., Sun, J., & Hu, X. (2017). A special Partial Least Squares (PLS) path decision modeling for bid evaluation of large construction projects. *KSCE Journal of Civil Engineering*, 21(3), 579–592. <https://doi.org/10.1007/s12205-016-0702-3>
- Lourenço, J. C., Morton, A., & Bana e Costa, C. A. (2012). PROBE - A multicriteria decision support system for portfolio robustness evaluation. *Decision Support Systems*, 54(1), 534–550. <https://doi.org/10.1016/j.dss.2012.08.001>
- Madeira, A. G., Cardoso, M. M., Belderrain, M. C. N., Correia, A. R., & Schwanz, S. H. (2012). Multicriteria and multivariate analysis for port performance evaluation. *International Journal of Production Economics*, 140(1), 450–456. <https://doi.org/10.1016/j.ijpe.2012.06.028>
- Marcarelli, G., & Nappi, A. (2019). Multicriteria approach to select the most economically advantageous tender: The application of AHP in Italian public procurement. *Journal of Public Procurement*, 19(3), 201–223. <https://doi.org/10.1108/JOPP-05-2018-0020>
- Marović, I., Perić, M., & Hanak, T. (2021). A multi-criteria decision support concept for selecting the optimal contractor. *Applied Sciences*, 11(4), 1660. <https://doi.org/10.3390/app11041660>
- Marques, G., Gourc, D., & Lauras, M. (2011). Multi-criteria performance analysis for decision making in project management. *International Journal of Project Management*, 29(8), 1057–1069. <https://doi.org/10.1016/j.ijproman.2010.10.002>
- Mateus, R. J. G., Bana e Costa, J. C., & Matos, P. V. (2017). Supporting multicriteria group decisions with MACBETH tools: Selection of sustainable brownfield redevelopment actions. *Group Decision and Negotiation*, 26(3), 495–521. <https://doi.org/10.1007/s10726-016-9501-y>
- Minchin Jr., R. E., & Smith, G. R. (2005). Quality-based contractor rating model for qualification and bidding purposes. *Journal of Management in Engineering*, 21(1), 38–43. [https://doi.org/10.1061/\(ASCE\)0742-597X\(2005\)21:1\(38\)](https://doi.org/10.1061/(ASCE)0742-597X(2005)21:1(38))
- Mohamad, R., Hamdan, A. R., Othman, Z. A., & Noor, N. M. M. (2010). Decision support systems (DSS) in construction tendering processes. *International Journal of Computer Science Issues*, 7(2), 35–45. <https://doi.org/10.1109/ICSSM.2008.4598482>

- Monat, J. P. (2009). The benefits of global scaling in multi-criteria decision analysis. *Judgment and Decision Making*, 4(6), 492–508.
- Osgood, C. E., Suci, G. J., & Tannenbaum, P. H. (1957). *The measurement of meaning* (47th ed.). University of Illinois Press.
- Pang, J., & Liang, J. (2012). Evaluation of the results of multi-attribute group decision-making with linguistic information. *Omega*, 40(3), 294–301. <https://doi.org/10.1016/j.omega.2011.07.006>
- Phogat, S., & Gupta, A. K. (2019). Evaluating the elements of just in time (JIT) for implementation in maintenance by exploratory and confirmatory factor analysis. *International Journal of Quality and Reliability Management*, 36(1), 7–24. <https://doi.org/10.1108/IJQRM-12-2017-0279>
- Russell, J. S., & Skibniewski, M. J. (1988). Decision criteria in contractor prequalification. *Journal of Management in Engineering*, 4(2), 148–164. [https://doi.org/10.1061/\(asce\)9742-597x\(1988\)4:2\(148\)](https://doi.org/10.1061/(asce)9742-597x(1988)4:2(148))
- Russell, J. S., & Skibniewski, M. J. (1990). QUALIFIER-1: Contractor prequalification model. *Journal of Computing in Civil Engineering*, 4(1), 77–90. [https://doi.org/10.1061/\(ASCE\)0887-3801\(1990\)4:1\(77\)](https://doi.org/10.1061/(ASCE)0887-3801(1990)4:1(77))
- Russell, J. S., Skibniewski, M. J., & Cozier, D. R. (1990). Qualifier-2: Knowledge-based system for contractor prequalification. *Journal of Construction Engineering and Management*, 116(1), 157–171. [https://doi.org/10.1061/\(ASCE\)0733-9364\(1990\)116:1\(157\)](https://doi.org/10.1061/(ASCE)0733-9364(1990)116:1(157))
- San Cristóbal, J. R. (2012). Contractor selection using multicriteria decision-making methods. *Journal of Construction Engineering and Management*, 138(6), 751–758. [https://doi.org/10.1061/\(ASCE\)CO.1943-7862.0000488](https://doi.org/10.1061/(ASCE)CO.1943-7862.0000488)
- Semaan, N., & Salem, M. (2017). A deterministic contractor selection decision support system for competitive bidding. *Engineering, Construction and Architectural Management*, 24(1), 61–77. <https://doi.org/10.1108/ECAM-06-2015-0094>
- Tabachnick, B. G., & Fidell, L. S. (2007). *Using multivariate statistics* (5th ed.). Pearson Education.
- Taylan, O., Kabli, M. R., Porcel, C., & Herrera-Viedma, E. (2017). Contractor selection for construction projects using consensus tools and Big Data. *International Journal of Fuzzy Systems*, 20(4), 1267–1281. <https://doi.org/10.1007/s40815-017-0312-3>
- Topcu, Y. I. (2004). A decision model proposal for construction contractor selection in Turkey. *Building and Environment*, 39(4), 469–481. <https://doi.org/10.1016/j.buildenv.2003.09.009>
- Tosun, Ö. (2017). Using MACBETH method for technology selection in production environment. *American Journal of Data Mining and Knowledge Discovery*, 2(1), 37–41.
- Vahdani, B., Mousavi, S. M., Hashemi, H., Mousakhani, M., & Tavakkoli-Moghaddam, R. (2013). A new compromise solution method for fuzzy group decision-making problems with an application to the contractor selection. *Engineering Applications of Artificial Intelligence*, 26(2), 779–788. <https://doi.org/10.1016/j.engappai.2012.11.005>
- Vieira, A. C. L., Oliveira, M. D., & Bana e Costa, C. A. (2020). Enhancing knowledge construction processes within multicriteria decision analysis: The Collaborative Value Modelling framework. *Omega*, 94, 102047. <https://doi.org/10.1016/j.omega.2019.03.005>
- Wang, W., Yu, W., Yang, I., Lin, C., Lee, M., & Cheng, Y.-Y. (2013). Applying the AHP to support the best-value contractor selection – lessons learned from two case studies in Taiwan. *Journal of Civil Engineering and Management*, 19(1), 24–36. <https://doi.org/10.3846/13923730.2012.734851>
- Watt, D. J., Kayis, B., & Willey, K. (2010). The relative importance of tender evaluation and contractor selection criteria. *International Journal of Project Management*, 28(1), 51–60. <https://doi.org/10.1016/j.ijproman.2009.04.003>
- Winterfeldt, V., & D., Edwards, R. (1986). *Decision analysis and behavioral research*. Cambridge University Press.
- Xiao, L., Chen, Z. S., Zhang, X., Chang, J. P., Pedrycz, W., & Chin, K. S. (2020). Bid evaluation for major construction projects under large-scale group decision-making environment and characterized expertise levels. *International Journal of Computational Intelligence Systems*, 13(1), 1227–1242. <https://doi.org/10.2991/ijcis.d.200801.002>
- Yang, J.-B., Wang, H.-H., Wang, W.-C., & Ma, S.-M. (2016). Using data envelopment analysis to support best-value contractor selection. *Journal of Civil Engineering and Management*, 22(2), 199–209. <https://doi.org/10.3846/13923730.2014.897984>
- Zhao, L., Liu, W., & Wu, Y. (2020). Bid evaluation decision for major project based on analytic hierarchy process and data envelopment analysis cross-efficiency model. *Journal of Ambient Intelligence and Humanized Computing*, 11(9), 3639–3647. <https://doi.org/10.1007/s12652-019-01564-z>

APPENDIX

Model's sensitivity analysis

Following figures denotes how the scale and weightage were modified in M-MACBETH tool. Typically, this process in MACBETH is called as Model Improvement phase (i.e., sensitivity analysis).

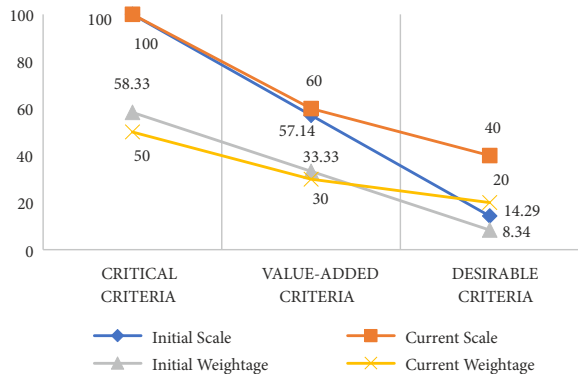

Figure A1. Model modification for categories

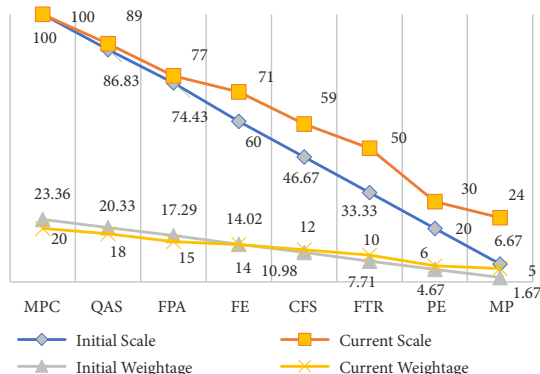

Figure A2. Model modification for criteria of critical criteria category

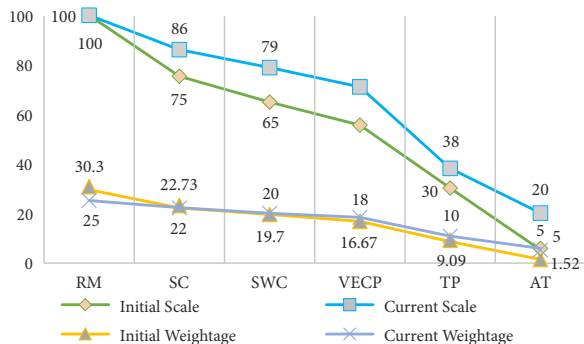

Figure A3. Model modification for value-added criteria

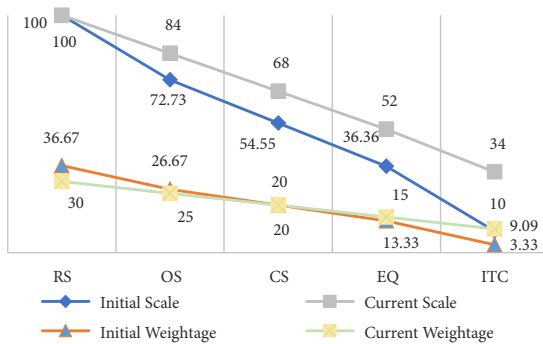

Figure A4. Model modification for desirable criteria

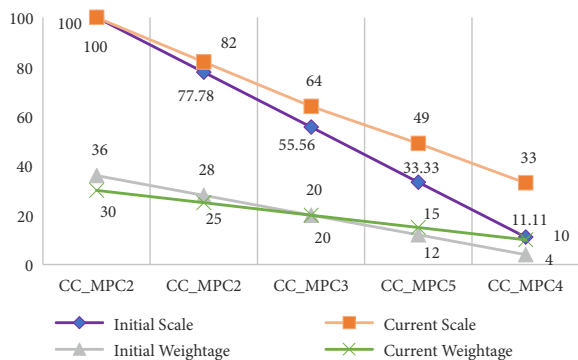

Figure A5. Model modification for sub-criteria of MPC

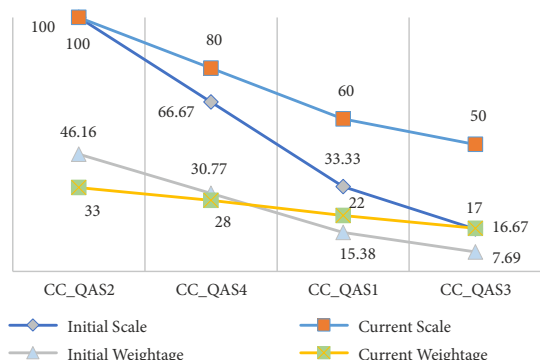

Figure A6. Model modification for sub-criteria of QAS

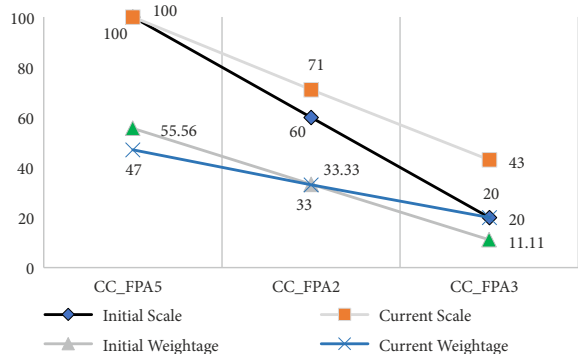

Figure A7. Model modification for sub-criteria of FPA

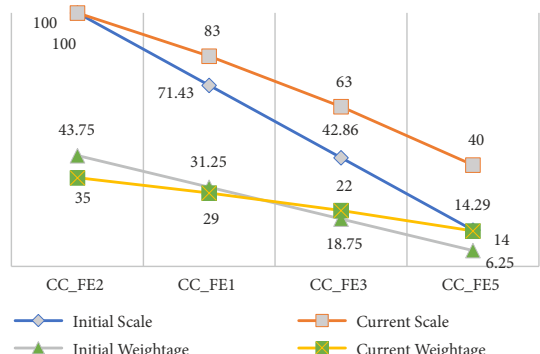

Figure A8. Model modification for sub-criteria of FE

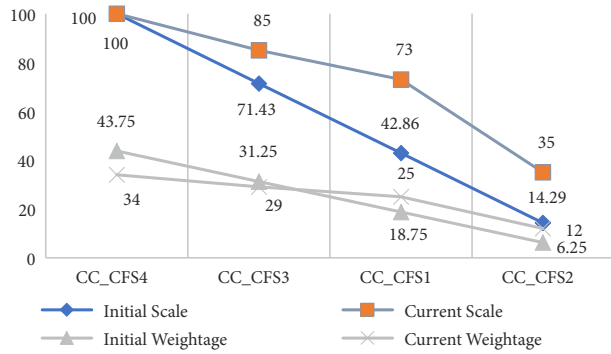

Figure A9. Model modification for sub-criteria of CFS

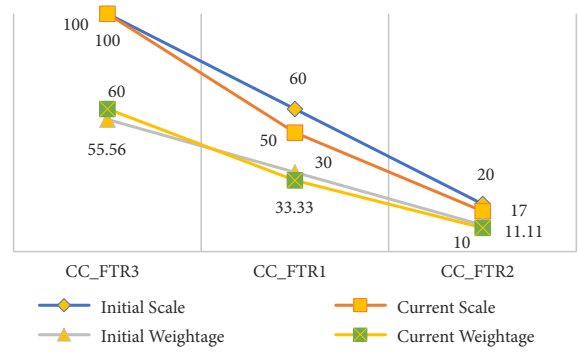

Figure A10. Model modification for sub-criteria of FTR

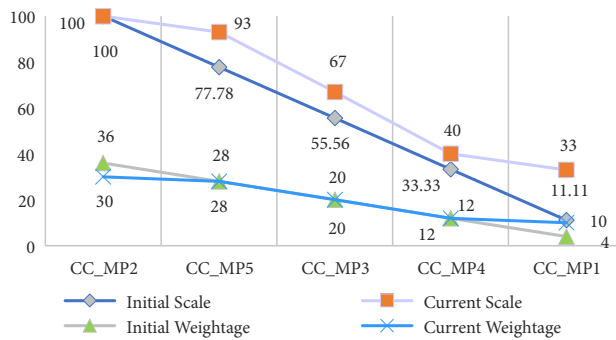

Figure A11. Model modification for sub-criteria of MP

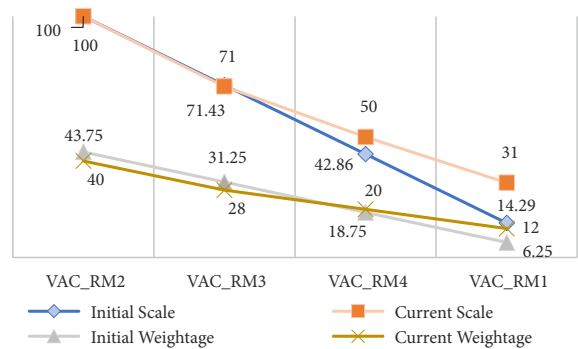

Figure A12. Model modification for sub-criteria of RM

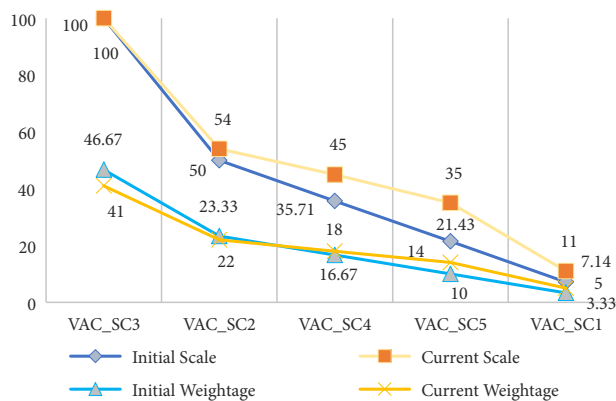

Figure A13. Model modification for sub-criteria of SC

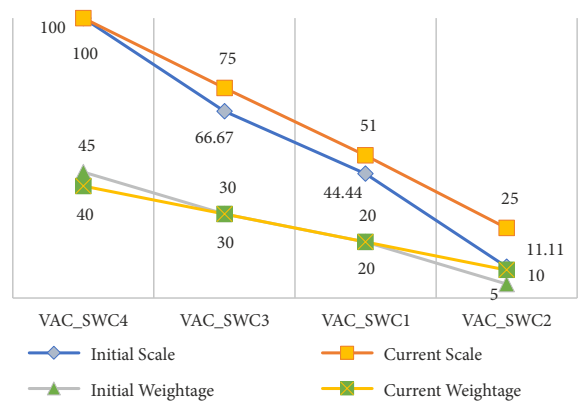

Figure A14. Model modification for sub-criteria of SWC

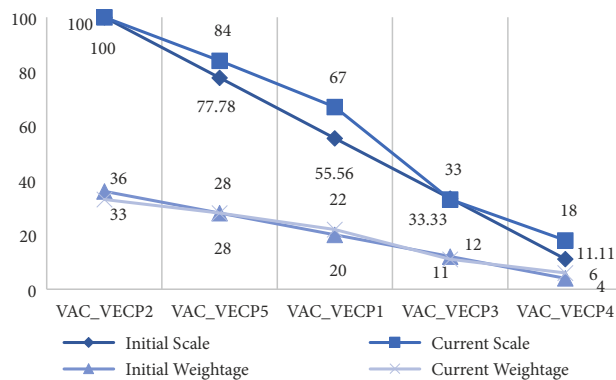

Figure A15. Model modification for sub-criteria of VECP

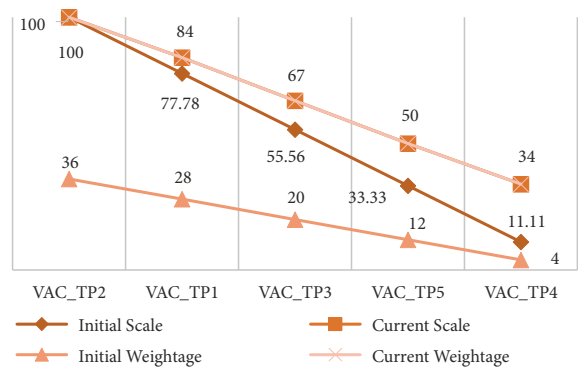

Figure A16. Model modification for sub-criteria of TP

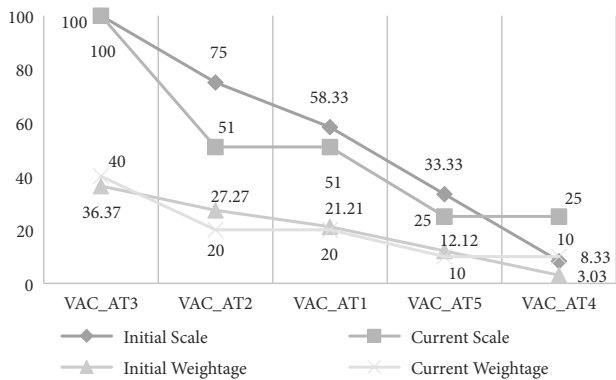

Figure A17. Model modification for sub-criteria of AT

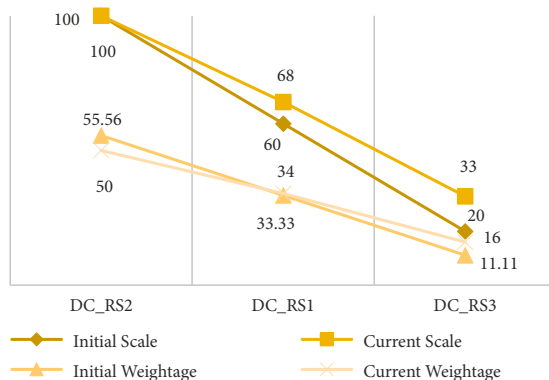

Figure A18. Model modification for sub-criteria of RS

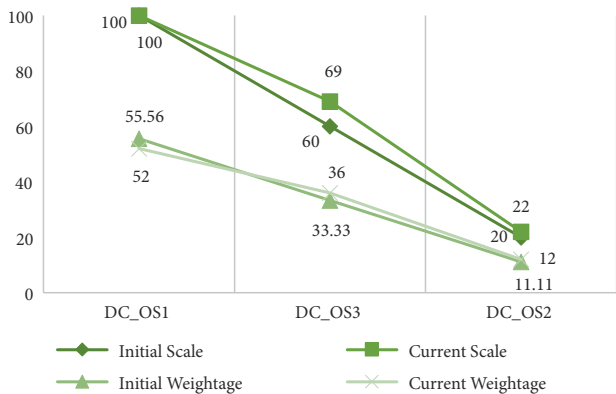

Figure A19. Model modification for sub-criteria of OS

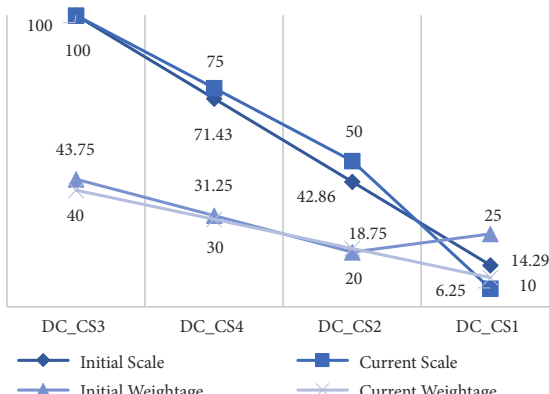

Figure A20. Model modification for sub-criteria of CS

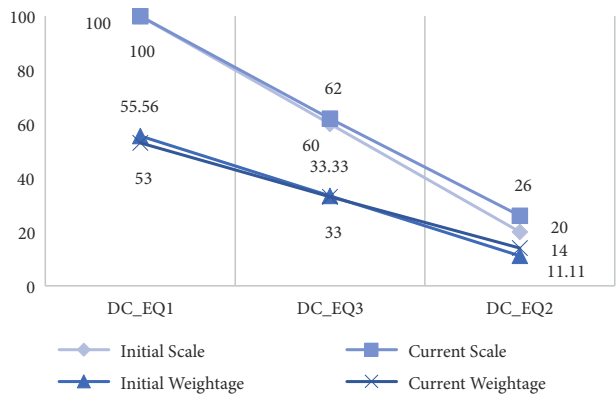

Figure A21. Model modification for sub-criteria of EQ

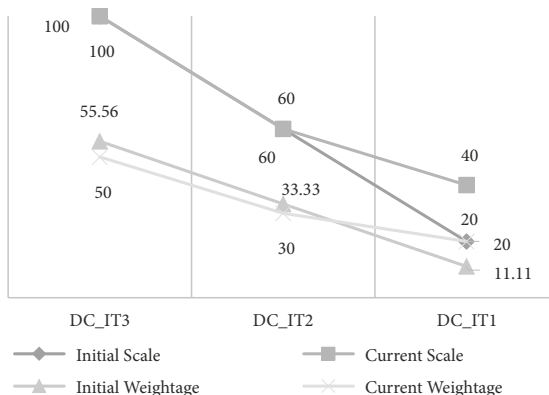

Figure A22. Model modification for sub-criteria of IT